

COATS®

1185 Wheel Balancer

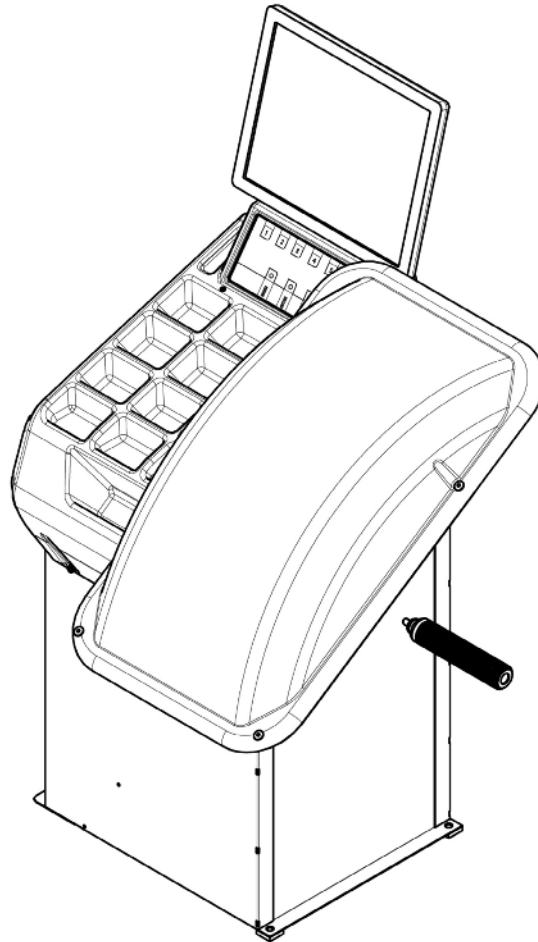

See
★ **Balancing Your
First Tire**
on page 1.

Safety Instructions **Set Up Instructions** **Operation Instructions** **Maintenance Instructions**

READ these instructions before placing unit in service. KEEP these and other materials delivered with the unit in a binder near the machine for ease of reference by supervisors and operators.

HENNESSY
INDUSTRIES

1601 J. P. Hennessy Drive, La Vergne, TN USA 37086 615/641-7533 800/688-6359 www.coatsgarage.com
HENNESSY INDUSTRIES LLC Manufacturer of COATS®, AMMCO® and BADA® Automotive Service Equipment and Tools.

Manual Part No.: 85611754 00
Revision: 08/20



NOTICE

Read entire manual before assembling, installing, operating, or servicing this equipment.

Table of Contents

Important Safety Instructions	iv - v	Menu	13 - 14
Owner's Responsibility.....	v	Menu Access Diagram	13
Operator Protective Equipment.....	v	Statistics.....	14
Definitions of Hazard Levels.....	v	Calibrations	15
Safety Notices and Decals	vi	Sensors Calibraton	15
★Balancing Your First Tire	1	Set Up	16 - 17
Principle Operating Parts	2 - 3	Language.....	16
Know Your Unit	2	Screen-Saver Time.....	16
Control Panel	3	Acoustic Signal	16
Operating the Balancer	4 - 12	Setting the Clock	16
Mounting Wheel on Balancer Shaft.....	4	Options.....	16
Standard Back Cone/Collet Mounting.....	4	AWA	16
Optional Front Cone/Collet Mounting.....	5	Balancing Set Up	17
Alternate Mounting	5	Diagnostics	17
Initial Screen.....	6	Inconsistent Unbalance Readings	17
Standard Balancing (Clip-On Counterweights).....	6	Wheel Balancing Machine SELF TEST.....	17
Result of the Measurement and Weight Application	7	Alarm Signal	18 - 19
Balancing with Adhesive Weights (Alu)	7	Installation Instructions	20 - 22
Result of the Measurement and Weight Application	8	Receiving.....	20
Balancing with a Mix of Adhesive and Clip-On Weights and Static Balancing.....	9	Standard Accessories.....	20
Static Unbalance	10	Specifications	20
Exact Positioning of the Adhesive Weight by Means of the Gauge with Clips.....	10	Electrical Requirements	20
Hide the Adhesive Weights (Split)	10	Floor and Space Requirements	21
Multiple Users	11	Unpacking the Unit.....	22
Automatic Minimization of Static Unbalance....	11	Hood Installation	22
Unbalance Optimization	12	Connect to Power.....	22
		Initial Testing	22

IMPORTANT SAFETY INSTRUCTIONS

READ ALL INSTRUCTIONS

1. Eye and face protection requirements:
“Protective eye and face equipment is required to be used where there is a reasonable probability of injury that can be prevented by the use of such equipment.” O.S.H.A. 1910.133(a) Protective goggles, safety glasses, or a face shield must be provided by the owner and worn by the operator of the equipment. Care should be taken to see that all eye and face safety precautions are followed by the operator. **ALWAYS WEAR SAFETY GLASSES.** Everyday glasses only have impact resistant lenses, they are not safety glasses.
2. Do not disable hood safety interlock system, or in any way shortcut safety controls and operations.
3. Be sure that wheels are mounted properly, the hub nut engages the arbor for not less than four (4) turns, and the hub nut is firmly tightened before spinning the wheel.
4. Read and understand this manual before operating. Abuse and misuse will shorten the functional life.
5. Be sure the balancer is properly connected to the power supply and electrically grounded.
6. Do not operate equipment with a damaged cord or if the equipment has been dropped or damaged – until it has been examined and repaired by a qualified serviceman.
7. Do not let cord hang over edge of table, bench, or counter or come in contact with hot manifolds or moving fan blades.
8. If an extension cord is necessary, a cord with a current rating equal to or more than that of the equipment should be used. Cords rated for less current than the equipment may overheat. Care should be taken to arrange the cord so that it will not be tripped over or pulled.
9. Keep guards and safety features in place and in working order.
10. Wear proper clothing. Safety toe, non-slip footwear and protective hair covering to contain hair is recommended. Do not wear jewelry, loose clothing, neckties, or gloves when operating the balancer.
11. Keep work area clean and well lighted. Cluttered and/or dark areas invite accidents.
12. Avoid dangerous environments. Do not use power tools or electrical equipment in damp or wet locations, or expose them to rain.
13. Avoid unintentional starting. Be sure the balancer is turned OFF and power disconnected before servicing.
14. Disconnect the balancer before servicing.
15. Use only manufacturer’s recommended accessories. Improper accessories may result in personal injury or property damage.
16. Repair or replace any part that is damaged or worn and that may cause unsafe balancer operation. Do not operate damaged equipment until it has been examined and serviced by an authorized service technician only. This unit contain no user serviceable parts.
17. Never overload or stand on the weight tray or any part of the balancer.
18. Do not allow untrained persons to operate machinery.
19. To reduce the risk of fire, do not operate equipment in the vicinity of open containers or flammable liquids (gasoline).
20. Adequate ventilation should be provided when working on or operating internal combustion engines.
21. Keep hair, loose clothing, fingers, and all parts of body away from moving parts.
22. Use equipment only as described in this manual. Do not modify the unit or remove protective covers or housings.
23. Use only manufacturer’s recommended attachments and accessories.
24. The laser unit is not to be opened [except for battery change (where applicable) or modified by the customer, nor is it allowed to attempt to cheat or defeat safety interlocks (where applicable)]. Never operate the laser if defective or cover/seal is defective.
25. Do not point laser or allow laser light to be directed or reflected toward other people or reflective objects. Potential eye or skin exposure to laser radiation exists if these instruction are not followed.

SAVE THESE INSTRUCTIONS

Important Safety Instructions

Owner's Responsibility

To maintain machine and user safety, the responsibility of the owner is to read and follow these instructions:

- Follow all installation instructions.
- Make sure installation conforms to all applicable Local, State, and Federal Codes, Rules, and Regulations; such as State and Federal OSHA Regulations and Electrical Codes.
- Carefully check the unit for correct initial function.
- Read and follow the safety instructions. Keep them readily available for machine operators.
- Make certain all operators are properly trained, know how to safely and correctly operate the unit, and are properly supervised.
- Allow unit operation only with all parts in place and operating safely.
- Carefully inspect the unit on a regular basis and perform all maintenance as required.
- Service and maintain the unit only with authorized or approved replacement parts.
- Keep all instructions permanently with the unit and all decals/labels/notices on the unit clean and visible.
- Do not override safety features.

Operator Protective Equipment

Personal protective equipment helps make tire servicing safer. However, equipment does not take the place of safe operating practices. Always wear durable work clothing during tire service activity. Loose fitting clothing should be avoided. Tight fitting leather gloves are recommended to protect operator's hands when handling worn tires and wheels. Sturdy leather work shoes with steel toes and oil resistant soles should be used by tire service personnel to help prevent injury in typical shop activities. Eye protection is essential during tire service activity. Safety glasses with side shields, goggles, or face shields are acceptable. Back belts provide support during lifting activities and are also helpful in providing operator protection. Consideration should also be given to the use of hearing protection if tire service activity is performed in an enclosed area, or if noise levels are high.

Definitions of Hazard Levels

Identify the hazard levels used in this manual with the following definitions and signal words:

DANGER

Watch for this symbol:



It Means: Immediate hazards, which will result in severe personal injury or death.

WARNING

Watch for this symbol:



It Means: Hazards or unsafe practices, which could result in severe personal injury or death.

CAUTION

Watch for this symbol:



It Means: Hazards or unsafe practices, which may result in minor personal injury or product or property damage.



Watch for this symbol! It means BE ALERT! Your safety, or the safety of others, is involved!

Safety Notices and Decals



Failure to follow danger, warning, and caution instructions may lead to serious personal injury or death to operator or bystander or damage to property. Do not operate this machine until you read and understand all the dangers, warnings and cautions in this manual. For additional copies of either, or further information, contact:

Hennessy Industries LLC

1601 JP Hennessy Drive
 LaVergne, TN 37086
 (615) 641-7533 or (800) 688-6359
www.hennessyind.com



 WARNING	 AVERTISSEMENT
<p>RISK OF EXPLOSION This equipment has internal arcing or sparking parts which should not be exposed to flammable vapors. Do not locate in a recessed area or below floor level.</p> <p>THIS EQUIPMENT MUST BE EARTH-GROUNDED The earth-ground connector built into the power cord provides protection to reduce the risk of electrical shock.</p>	<p>RISQUE D'EXPLOSION Cet équipement possède des pièces internes, pouvant lancer des arcs ou jeter des étincelles, et qui ne devraient pas être exposées à des vapeurs inflammables. Ne situez pas l'équipement dans des endroits encastrés ou en-dessous du niveau du plancher.</p> <p>CET ÉQUIPEMENT DOIT ÊTRE MIS À LA TERRE Le raccord de mise à la terre incorporé dans le cordon de puissance fournit une protection afin de réduire le risque d'électrocution.</p>
 CAUTION	 ATTENTION
<p>Do not use below garage floor or grade level.</p> <p>Disconnect power before servicing this equipment.</p> <p>To prevent electrical shock, do not remove cover. No user serviceable parts inside. Refer servicing to qualified service personnel.</p>	<p>N'utilisez pas en-dessous du plancher de garage ou du palier.</p> <p>Débranchez le cordon de puissance avant de faire l'entretien de cet équipement.</p> <p>Afin de vous protéger contre l'électrocution, n'enlevez pas le couvercle. Aucune pièce interne ne nécessite d'entretien par l'utilisateur. Référez l'entretien à un personnel de service qualifié.</p>
8113927 05	

 **WARNING**

Maximum Size of Wheel Rating

Weight	Diameter	Width
130 lbs.	38 in.	16in.

85008890 00

Standard Safety Devices

- Stop push button for stopping the wheel under emergency conditions.
- A hood guard of high impact plastic that is designed to prevent the counterweights from flying out in any direction except towards the floor.

★Balancing Your First Tire

1. Turn the machine OFF then ON (resets machine).

Note: The machine wakes up using standard clip-on wheel weight locations (c1 & c2) and wheel dimensions.

2. Mount a tire/wheel on the balancer that will use standard clip-on wheel weights.

Use the most appropriate mounting method.

3. Always remove any weights already attached to the wheel.

4. Enter A & D wheel dimensions using offset arm.

Automatic Measurement — pull offset arm out to the wheel, hold it still at clip-on weight position against wheel flange. Return arm to home position.



Figure 1 - Offset Arm At Clip-On Weight Location

5. Enter Width wheel dimension.

Use plastic calipers to measure wheel width.
Use keypad to enter Width value.

6. Lower the hood, press Start; wheel spins and unbalances are measured and displayed.

The corrective weight amount appears in the digital readout windows.

7. Raise hood after tire stops rotating.

Note: Wait for wheel to stop before raising the hood.

8. Rotate wheel to inboard (left plane) position of unbalance.

9. Attach inboard (left plane) corrective weight.

Attach specified weight amount at top-dead-center on inside flange of wheel.

10. Rotate wheel to outboard (right plane) position of unbalance.

11. Attach outboard (right plane) corrective weight.

Attach specified weight amount at top-dead-center on outside flange of wheel.

12. Lower the hood to respin the tire/wheel and check balance.

Your weight readings should now be 0.00.

Note: Throughout this manual tire dimensions are referred to as A, W, and D, see figure 2.

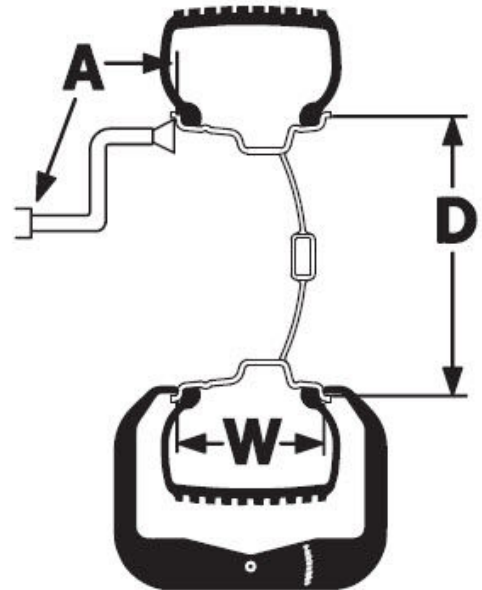

A, W and D Tire Dimensions

Principle Operating Parts



Do It Now!

Now is a good time to fill out the Owner's Registry Card.

Know Your Unit

Compare this illustration with the unit before placing it into service. Maximum performance and safety will be obtained only when all persons using the unit are fully trained in its parts and operation. Each user should learn the function and location, of all controls.

Prevent accidents and injuries by ensuring the unit is properly installed, operated and maintained.

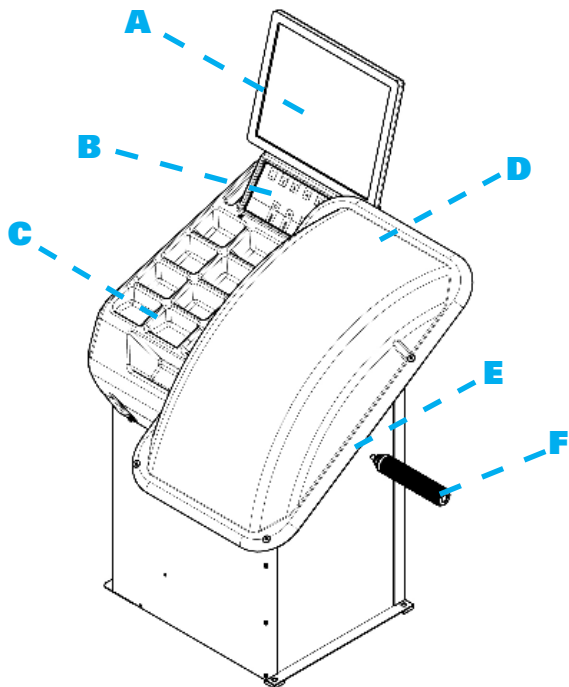

- A** - Video Display Panel
- B** - Touch Control Panel
- C** - Weight Tray with Pockets for Corrective Weights
- D** - Hood Guard
- E** - Offset Arm, Measures A & D of Tire/Wheel
(shown in home position)
- F** - 40mm Shaft

Note: Throughout this manual wheel weights are referred to as Clip-on or Tape-A-Weight™. Figure 3 shows an example of each weight.

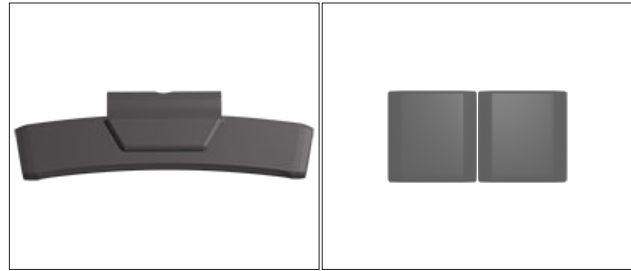

Clip-on Weight

Tape-A-Weight

Corrective Weight Examples. For Best Results, use BADA® Brand Wheel Weights.

Power Switch



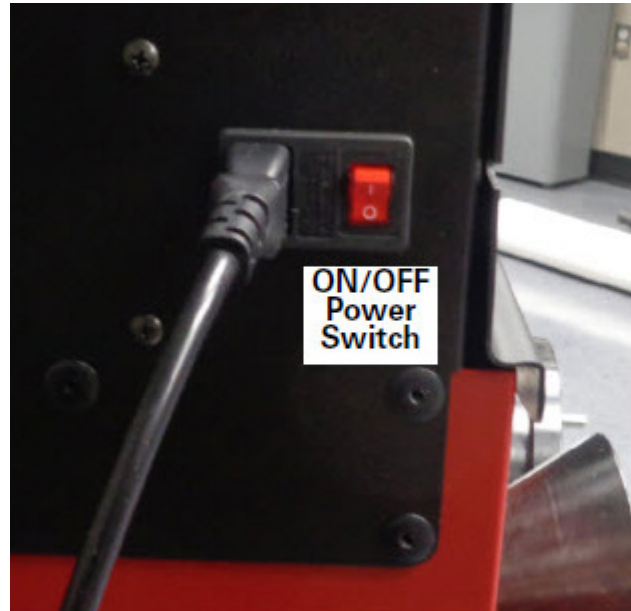

The ON/OFF switch is located on the back of the balancer.

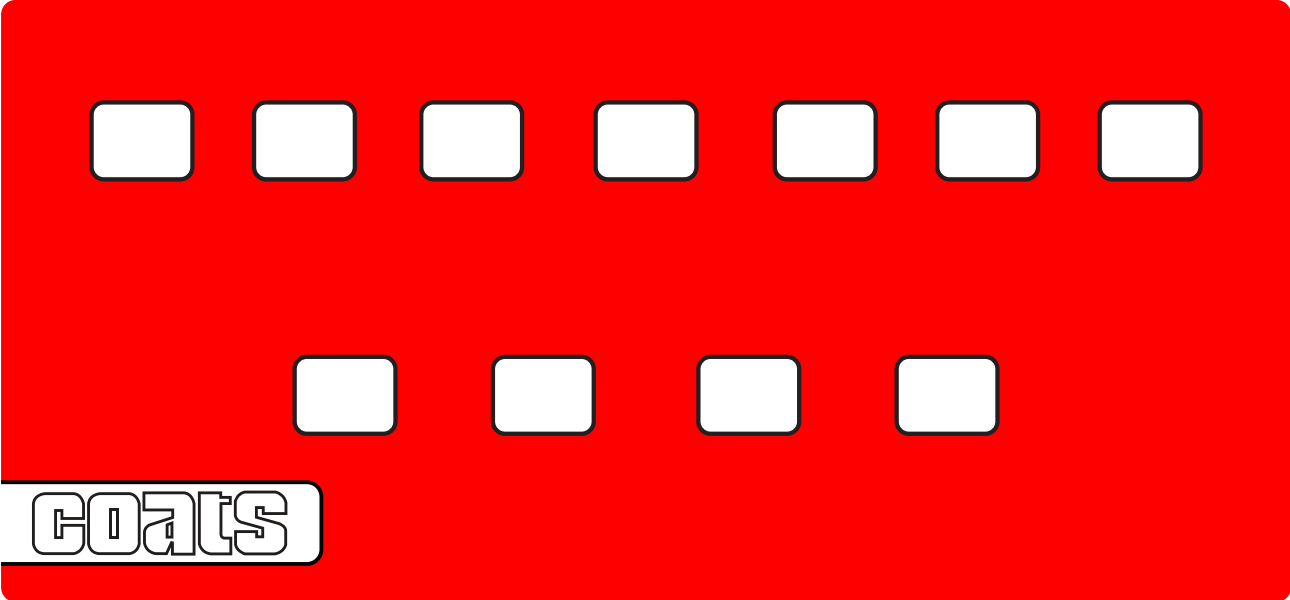

ON/OFF Switch

Control Panel



-  Indicators, selection made
-  Push button, FUNCTIONS MENU
-  Push button, menu selection confirmation
-  Push button, cycle start
-  Push button, cycle stop

Operating the Balancer Mounting Wheel on Balancer Shaft



Avoid back injury, seek assistance when lifting heavy tire/rim assemblies onto the balancer shaft.



Failure to tighten the hub nut properly may result in the wheel dismounting, causing personal injury and property damage.

Select the most appropriate mounting method for the wheel you are balancing. Using the proper method ensures secure mounting and safe balancer operation, and prevents damage to the wheel.

On most wheels, the inner side of the wheel hub usually has the most uniform surface for wheel balancing. Always center the wheel by the most uniform shaped side of the hub to achieve the most accurate balance.

Regardless of mounting type, always make sure that the wheel is forced firmly against the shaft faceplate and that the hub nut engages the threaded shaft for at least four complete turns. To assist in centering the wheel properly, rotate the wheel and the shaft while tightening the hub nut.

Standard Back Cone/Collet Mounting

Most original equipment and steel wheels can be mounted properly using this method. The wheel is centered on a cone from the inner side of the hub.

1. Select the cone/collet that best fits the center hole in the wheel. Slide the cone/collet onto the shaft with the large end towards the cone spring.

2. Lift wheel onto the shaft and center it on the cone/collet.

3. Attach the pressure cup to the hub nut. Install the Hub nut assembly onto the shaft and tighten it securely against the wheel. The wheel must be forced firmly against the faceplate. The hub nut must engage the threads for at least four full turns.

Note: Use a nylon spacer (protective ring) to protect custom wheel finishes.

Note: If the hub nut will not tighten completely, use the front cone mounting method.

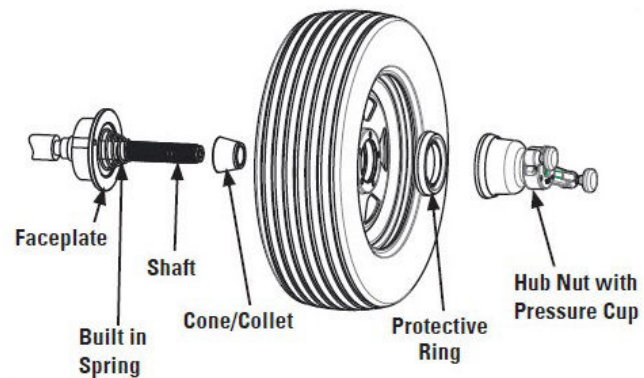

Standard Back Cone/Collet Mounting

Optional Front Cone/Collet Mounting

A wheel should be centered by the outer side of the hub only when the inner surface will not provide an accurate surface to center on.

1. Select the cone that best fits the center hole in the wheel.
2. Lift the wheel onto the shaft and slide it back against the shaft faceplate.
3. Slide the cone onto the shaft and into the center of the wheel. You will need to lift the tire to seat the cone in the center hole.
4. Install the hub nut (without pressure cup) onto the shaft. Tighten it securely against the cone. The hub nut must engage the threads for at least four full turns.

Note: If the hub nut will not tighten completely because of a lack of threads, use an additional cone as a spacer between the mounting cone and the hub nut. The wheel must be forced firmly against the faceplate.

Note: Do not front cone chrome or clad wheels.

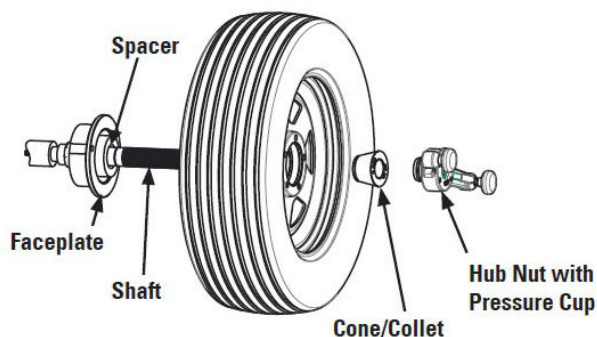

Front Cone/Collet Mounting

Alternate Mounting

If the wheel has a protruding outer hub which will not permit the use of the pressure cup, or the cup will not permit the hub nut to engage at least four turns of the shaft, this alternate method should be used.

1. Place the cone spring onto the balancer shaft with the large end towards the faceplate.
2. Select the cone/collet that best fits the center hole in the wheel. Slide the cone/collet onto the shaft with the large end towards the faceplate.
3. Lift wheel onto the shaft and center it on the cone/collet.
4. Use the small nylon spacer (no-mar ring) or a centering cone/collet to press against the outer wheel hub.
5. Install the hub nut (without the pressure cup) onto the shaft. Tighten securely.

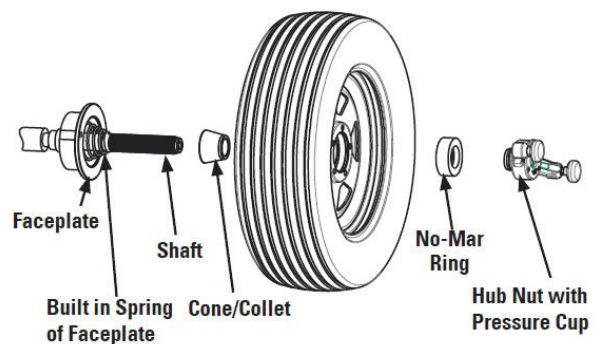

Alternate Mounting

Initial Screen

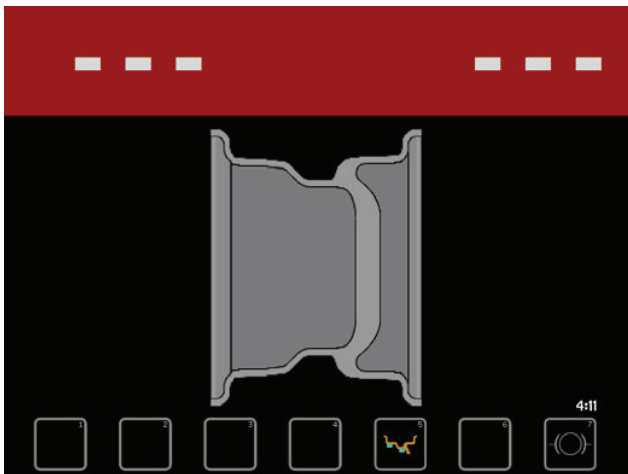

- selects the correction type
- displays the residual out-of-balance (option)
- wheel locks/unlocks
- main functions screen
(👉 **MENU ACCESS DIAGRAM**)

Dimensions gauge: pulling it out, it measures the wheel dimensions (👉 **WHEEL DIMENSIONS SETTING**).

If the machine remains on the initial screen for a certain amount of time without being used, the system is automatically switched to a screen-save. Striking of any key, movement of the wheel or distance + diameter gauge will cause automatic switching from the screen-save menu to the initial screen.



When the screensaver is active, automatic starting activated by the wheel guard is not available for safety reasons.

Standard Balancing (Clip-On Counterweights)

Wheel dimensions setting

Using the special grip, move the end of gauge against the rim as shown in the figure:

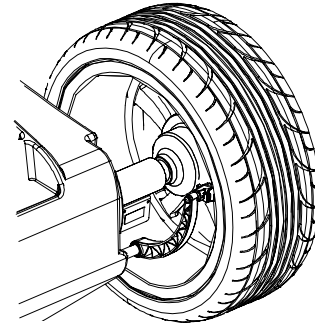

Hold the gauge in position for at least 2 seconds.

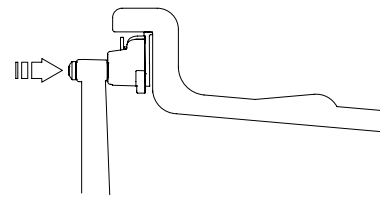

If the acoustic signal is enabled (MENU - ACOUSTIC SIGNAL), the dimensions acquisition is accompanied by a beep.

Set the gauge to the rest position.

Set the width value shown on the tire and proceed with balancing the wheel.

If the wheel dimensions have been entered incorrectly, the parameters can be modified without repeating the balancing spin.

From the measurement screen press



Manual width setting

Press / to set the width "b" in manual mode.

Normally the "nominal" width is indicated on the wheel; otherwise, measure the dimension "b" with the supplied caliper gauge.

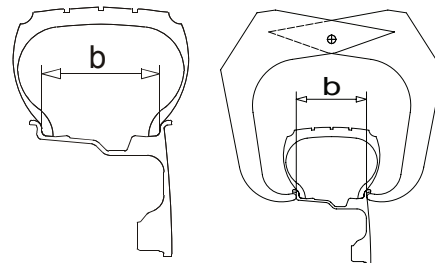

Result of the Measurement and Weight Application

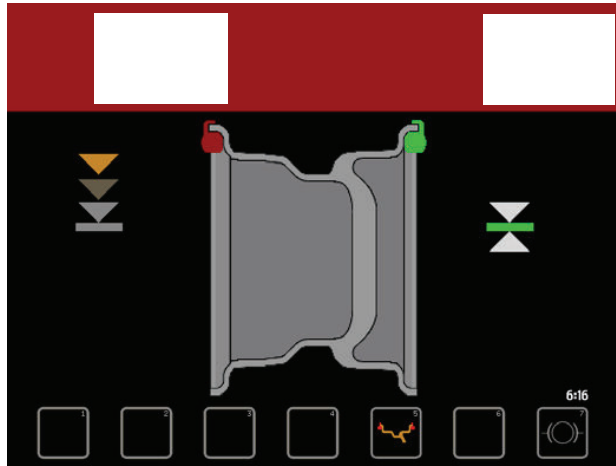

Inside unbalance indicator

Outside unbalance indicator

If the unbalance is out of tolerance:

1. At the end of the spin, the wheel automatically comes near to the outer side (on the inner side if the outer side is already within tolerance). In case of both sides (or static) within tolerance, no approaching is carried out. The spindle is automatically locked in correction position (if not disabled the spindle lock and for rotation speeds less than 20 rpm).

If the acoustic signal is enabled (MENU - ACOUSTIC SIGNAL), a beep will sound when the correction position has been reached.

2. The symbol is shown on the display on the side corresponding to the active correction plane.

If a flashing arrow appears, move slightly by hand the wheel to complete positioning on the correction plane.

3. *Manually* apply the number of weights shown on the display on the rim at 12 o'clock using clip-on weights:



Note: If the out-of-balance is less than the chosen threshold value, "0" appears instead of the out-of-balance value to indicate, on that particular side, that the wheel is in tolerance; If AUTOADAPTIVE is dis-

abled, press to display the FINE MODE value below the chosen threshold.

4. Press to position the wheel in proximity of the other side and correct the unbalance according to what is shown on the screen

5. After applying the weights, perform spin check to check the correction made checking that both planes are within tolerance.

Enabled buttons:

measuring spin with closed wheel guard/ automatic wheel positioning in proximity of correction position with open wheel guard

selects the correction mode. When the mode is changed, the unbalance values are recalculated automatically on the basis of the previous spin. Simultaneous display of the dynamic+static unbalance can be enabled through the special function in Setup (STATIC ALWAYS ENABLED)

displays the residual out-of-balance (option)

wheel locks/unlocks.

Balancing with Adhesive Weights (Alu) Wheel dimensions setting

Using the dedicated grip, move the gauge tip up against the inside of the rim and make two consecutive measurements starting from the inside (FI) as shown in the figure. The two preselected positions coincide with the point where the counterweight is to be applied.

if the acoustic signal is enabled (MENU - ACOUSTIC SIGNAL), the dimensions acquisition is accompanied by a beep.

Set the gauge to the rest position.

Slowly lower the guard and perform a measurement spin.

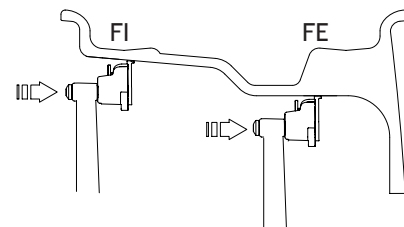

Note: If AutoAdaptive correction method is enabled (Balancing Setup), the width has to be acquired as indicated in the paragraph Standard balancing - setting the wheel dimensions.

Result of the Measurement and Weight Application

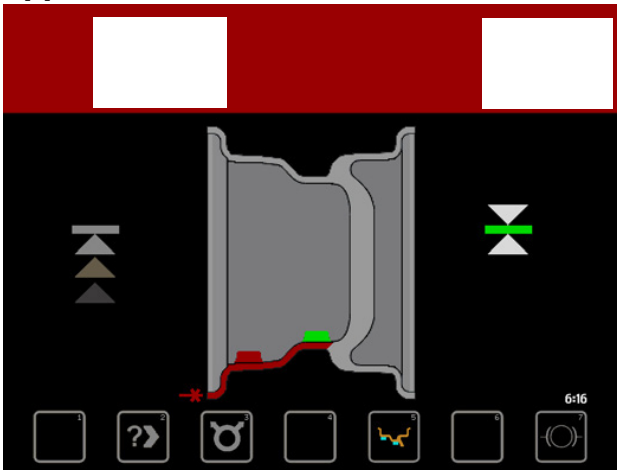



Inside unbalance indicator

Outside unbalance indicator

If the unbalance is out of tolerance:

1. At the end of the spin, the wheel automatically comes near to the outer side (on the inner side if the outer side is already within tolerance). In case of both sides (or static) within tolerance, no approaching is carried out. The spindle is automatically locked in correction position (if not disabled the spindle lock and for rotation speeds less than 20 rpm).

If the acoustic signal is enabled ( MENU - ACOUSTIC SIGNAL), a beep will sound when the correction position has been reached.

2. The symbol  is shown on the display on the side corresponding to the active correction plane.

If a flashing arrow appears, move slightly by hand the wheel to complete positioning on the correction plane.

Note: If the out-of-balance is less than the chosen threshold value, "0" appears instead of the out-of-balance value to indicate, on that particular side, that the wheel is in tolerance; If AUTOADAPTIVE is dis-

abled, press  to display the FINE MODE value below the chosen threshold.

3. Press  to position the wheel in proximity of the other side and correct the unbalance according to what is shown on the screen



4. After applying the weights, perform spin check to check the correction made checking that both planes are within tolerance.

Enabled buttons:

 measuring spin with closed guard/automatic wheel positioning in proximity of the correction position with open guard

 enables the indication of the longitudinal position of the out-of-balance

 enables the unbalance SPLIT function

 selects the correction mode. When the mode is changed, the unbalance values are recalculated automatically on the basis of the previous spin. Simultaneous display of the dynamic+static unbalance can be enabled through the special function in Setup ( STATIC ALWAYS ENABLED)





 displays the residual out-of-balance (option)

 wheel locks/unlocks.

Balancing with a Mix of Adhesive and Clip-On Weights and Static Balancing



3 , **4** , **5**

After dimension acquisition in standard balancing mode, pressing the buttons **3** , **4** , **5** , you can select one of the following correction modes.

WEIGHT APPLICATION POSITION		
Correction type	Inside	Outside
	Clip-on weight at 12 o'clock	Clip-on weight at 12 o'clock
	Clip-on weight at 12 o'clock	Adhesive weight at 12 o'clock
	Adhesive weight at the point indicated by the internal laser	Clip-on weight at 12 o'clock
	Adhesive weight at the point indicated by the internal laser	Adhesive weight at 12 o'clock
	Adhesive weight at the point indicated by the internal laser	

3 / **4**

After dimension acquisition in ALU mode, pressing the buttons **3** / **4** , you can select one of the following correction modes. The adhesive weight application distance and diameter are measured by means of the automatic distance and diameter gauge, except for the static unbalance where the dimensions acquired are modified following some fixed parameters.

WEIGHT APPLICATION POSITION		
Correction type	Inside	Outside
	Adhesive weight at the point indicated by the internal laser	Adhesive weight at the point indicated by the internal laser
	Clip-on weight at 12 o'clock	Adhesive weight at the point indicated by the internal laser
	Adhesive weight at the point indicated by the internal laser	

Note: If the laser is disabled, all the weight application positions are at 12 o'clock.

Static Unbalance

To display the static unbalance press the  button, then press the static weight. The correction weight application diameter cannot be set, but is deduced from the dimensions acquired in standard or ALU mode through interpolation algorithms and the use of fixed parameters.

Tolerance, brake and laser control is the same as for standard balancing, only that it refers to a single correction plane.

Exact Positioning of the Adhesive Weight by Means of the Gauge with Clips

The position repeater function can be accessed by

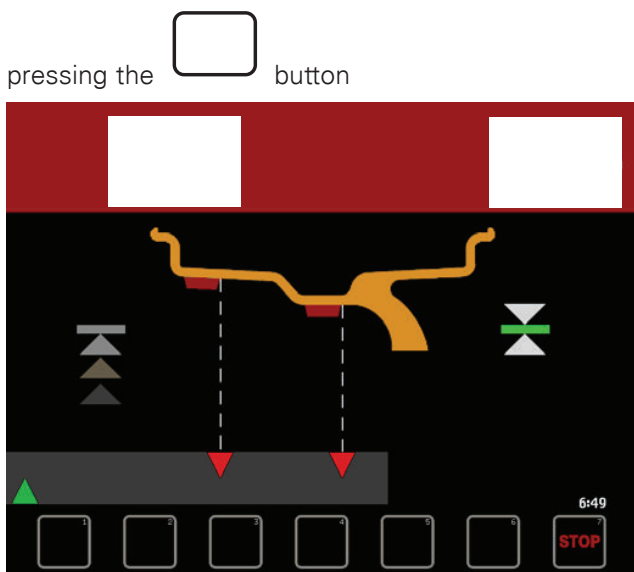

- pull out the gauge to position A

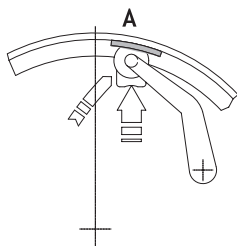
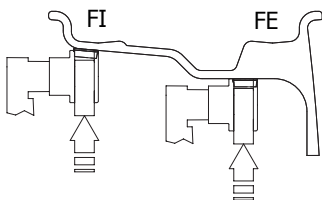

- a moving arrow [▲] indicates the approach of the weight towards the correction position.

- when a fixed arrow [▼] is reached, rotate the wheel to correction position (FI or FE) and apply the counterweight by rotating the gauge tip towards the outside, into the position where the pincer touches the wheel (where appropriate use the weight pusher)

- the correction weight application position is automatically reset in relation to the position of the distance + diameter gauge

Note: When the acoustic signal is enabled ((👉 ACOUSTIC SIGNAL), attainment of the fixed arrow status [▼] is accompanied by a "beep".

Hide the Adhesive Weights (Split)

SPLIT is only possible in the event of static unbalance or ALU external side and is used to hide any adhesive weights correcting unbalance behind the rim spokes.

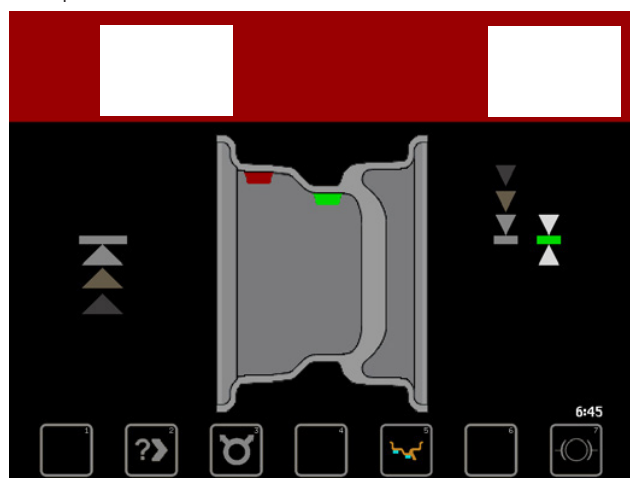

1. Position the static unbalance or outside ALU in the in the correction position: .

2. Press  and hold down until the laser points to the spoke where you want to hide the weight.

3. Release the  button.

4. Turn the wheel in the unbalance rotation direction indicated on the screen until the second spoke is in the position indicated by the laser and press the  button.

5. Two indications appear on the screen for positioning of the outside correction plane.

6. Press  to position automatically the wheel in proximity of the correction positions and correct the value displayed.

Multiple Users

It is possible to operate on four different vehicles at the same time, using the same wheel balancer.

The system keeps four programs in memory, each with different dimensions set.

Select from the automatic setting frame for standard wheels (( WHEEL DIMENSIONS SETTING)).



selects the user to call up and program

calls up the selected user

The system automatically returns to the initial screen with recalculation of the unbalance values on the basis of the effective dimensions of the USER called up.

programming the selected user.

Note: The dimensions memorized as USER are lost when the machine is switched off. You can enable the display of the current user on the measurements and dimensions screens.

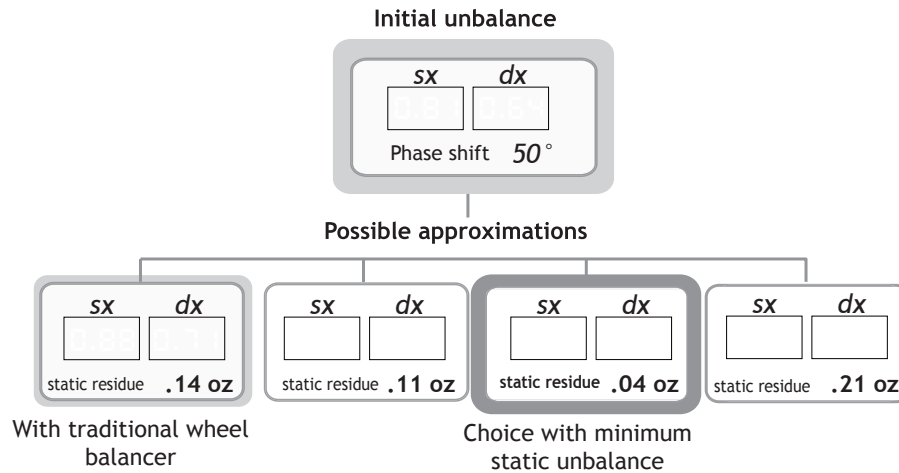



Automatic Minimization of Static Unbalance

This program is designed to improve the quality of balancing without any mental effort or loss of time by the operator. In fact by using the normal commercially available weights, with pitch of 5 in every 0.17 oz (5 g), and by applying the two counterweights which a conventional wheel balancer rounds to the nearest value, there could be a residual static unbalance of up to 0.14 oz (4 g). The damage of such approximation is emphasized by the fact that static unbalance is cause of most of disturbances on the vehicle. This new function, resident in the machine, automatically indicates the optimum entity of the weights to be applied by approximating them in an "intelligent" way according to their position in order to minimize residual static unbalance.

Unbalance Optimization

The program allows total wheel out-of-balance to be reduced by compensating, when possible, tire and rim out-of-balance values. It requires two runs, rotating the tire on the rim on the second run.

Having performed a run, press  +  and follow the on-screen instructions.



 returns to the previous screen

 returns to the measurement screen

Menu

Menu Access Diagram

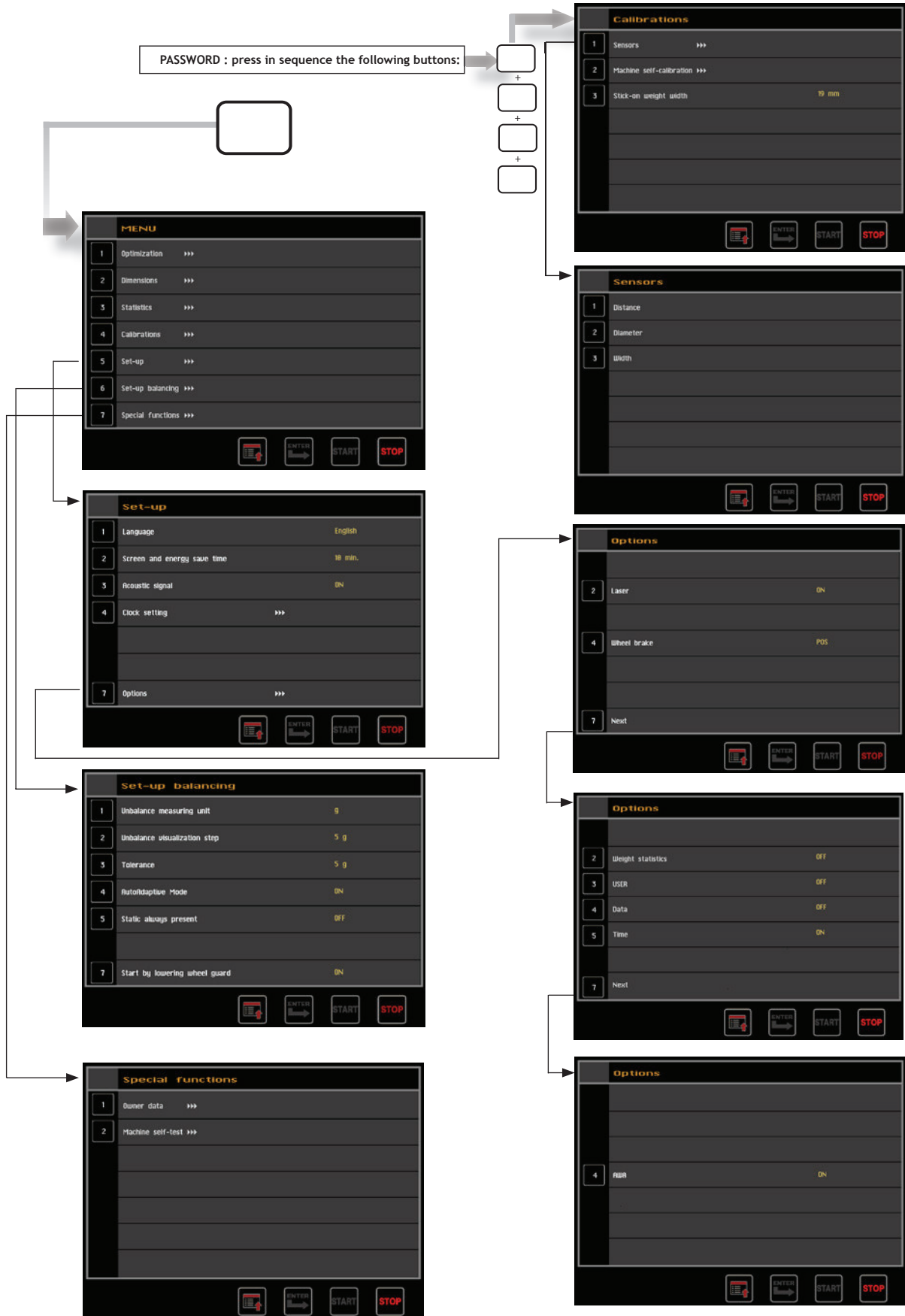

Statistics

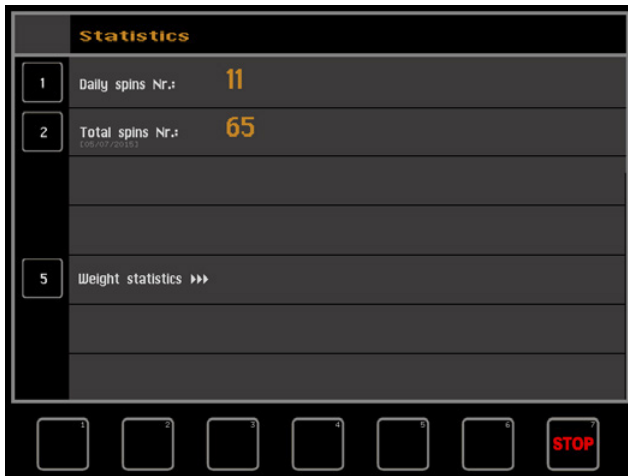

resets the relative counter

For the TOTAL counters a correct password must be entered



accesses to the weight statistics screen



returns to the previous screen

Daily N° Of Runs:

Indicates the number of runs performed as from switching on the machine. Such parameter is automatically reset after switching the machine off.

Total N° Of Runs:

Indicates the number of runs starting from the date indicated in square brackets. This parameter remains memorized even when the machine is switched off.

Weight statistics screen

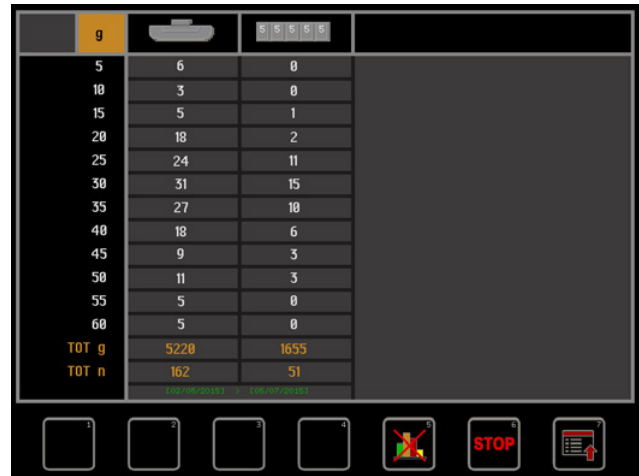

resets the weight statistics screen by pressing and entering the password



returns to the previous screen



returns to the measurement screen

Each horizontal line indicates the number of clip-on and adhesive weights used to balance the wheels in the period between the two dates indicated on the screen (in square brackets).

- Tot g (Tot oz): indicates the total weight value (clip-on and adhesive weights) used to balance the wheels in the interval indicated on the screen

- Tot n: indicates the total number of clip-on and adhesive weights used to balance the wheels in the interval indicated on the screen.

Note: To enable saving of the weight statistics

((WEIGHT STATISTICS SCREEN)).

The weights are saved only if the unbalance display pitch is set to 5 in 5.

Calibrations

When  is pressed from the Special Functions menu, access is gained to the Calibration menu.

Sensors Calibration

Distance gauge calibration

Note: Follow screen prompts on balancer.

Password:  ,  ,  , 

To calibrate the distance gauge, set it in rest position and then on the adapter plane.

When done, set the gauge in rest position. If calibration is correct, the wheel balancer is ready for operation, otherwise an error message may be displayed if there are errors or malfunctioning; in this case repeat calibration.

Enabled buttons:

 confirms

 cancels the distance gauge calibration function if has erroneously been accessed

Diameter gauge calibration

Note: Follow screen prompts on balancer.

Position the gauge rod of the spindle sleeve as indicated in the figure and press .

Rotate the gauge downwards and place the gauge rod in contact with the spindle sleeve as indicated in the figure and press

Enabled buttons:

 confirms

 cancels the diameter gauge calibration function if has erroneously been accessed

Balancing machine calibration

To calibrate the balancing machine, use a a 2-ounce calibration weight and wheel with steel rim of average dimensions, e.g. 6" x 15" (± 1 ").

To properly perform the procedure:

- Mount a wheel on the machine, even unbalanced, and very carefully set its dimensions.

Note: Setting incorrect measurements will result in the machine not being correctly calibrated, and balancing of subsequent wheels will hence be incorrect, until the machine is recalibrated with the correct measurements!!

- Follow the on-screen instructions.

Adhesive weight width

Indicates the average width of the adhesive weights on the market.

Change ONLY if the width of the adhesive weights used for unbalance correction differ ± 0.118 -inch (3 mm) with respect to that shown on the screen. Default=0.75-inch (19mm).

Set Up

The Setup screen provides the user with many possibilities required for presetting the machine according to his own requirements. Such settings remain unaltered even when the machine is switched off.

Enabled buttons:



returns to measurement screen



returns to previous screen



...



selects the parameter.

Language

This function allows selecting the language to be used for displaying descriptive and diagnostic messages regarding machine operation.

Screen-Saver Time

If this function is enabled, the screensaver will automatically be activated when the machine is not used for a certain period of time. This function can be disabled by setting it to 0.

Acoustic Signal

When "ON" is selected, the sending of an acoustic signal (beep) is enabled in the following cases:

- when any push button is pressed;
- when dimensions are acquired in automatic mode;
- when the correct angular position for weight application is reached in the Measurement screen.

Setting the Clock

Used to set date and time correctly. Follow the instructions on the screen.

Options

Laser

If enabled, the weight application position is indicated in correspondence to the laser (6 o'clock) to facilitate rim cleaning and adhesive weight application.

Wheel locking enable

OFF: disabled both the wheel locking and the automatic wheel positioning in proximity of the correction position
ON: enables the wheel locking in the correction position

POS: enables the wheel locking and the automatic wheel positioning in proximity of the correction position.

The flashing arrow indicates the fastest direction of rotation to bring the nearest wheel side to the correction position.

The positioning in proximity of the correction position is activated at the end of measurement spin and



by pressing the button with open guard.

Weight statistics

Enables/disables saving of the weight type used to balance the wheels (WEIGHT STATISTICS SCREEN).

User

Enables/disables user selection display.

Date

Enables/disables date display.

Time

Enables/disables time display.

Balancing Set Up

Unit of unbalance measurement

It is possible to select whether to display the unbalance values expressed in grams or ounces.

Unbalance display pitch

You can view the unbalances in steps of 1/4 oz or 0.1 oz (5 grams or 1 gram).

Notes: For full use of the wheel balancer functions, it is advisable to always set a display step of 1/4 oz (5 grams).

Tolerance

This is the unbalance threshold below which 0.00 appears on the screen at the end of the spin.

Static always enabled

Enables/disables the simultaneous display of the selected correction plane and STATIC unbalance.

Run with guard closed

By selecting "ON," the wheel balancer automatically starts to spin when the wheel guard is lowered.

Special Functions

Presetting the Customer and User Name

The machine can be customised by setting the name that appears on the screensaver.

Wheel Balancing Machine SELFTEST

An automatic self-diagnostic cycle is provided for easier trouble-shooting.

(Consult the extraordinary maintenance manual or contact Technical Service).

Diagnostics

Inconsistent Unbalance Readings

In some cases, when a wheel that has just been balanced is repositioned on the balancer, the machine can detect an unbalance.

This is not a machine problem but is due to faulty mounting of the wheel on the flange. In other words, when mounting the wheel after initial balancing, it has taken another position with respect to the balancer shaft axis.

If the wheel has been mounted on the flange with screws, the screws may not have been tightened correctly (crisscross sequence) or the tolerances of the holes drilled in the wheel may be too large. Small errors, up to 10 grams (0.4 oz), are to be considered normal in wheels locked with the relative cone: The error is normally greater for wheels locked with screws or studs.

If, after balancing, the wheel is still unbalanced when refitted on the vehicle, this could be due to an unbalanced brake drum or, very often, the tolerances of the holes drilled in the rim and drum are too large. In this case, balancing should be performed using a balancer with the wheel mounted on the vehicle.

Alarm Signal

The machine has a self-diagnostics cycle which identifies the most frequent malfunctions during the normal work cycle. These malfunctions are processed by the system and shown on the display.

Note: The information in the POSSIBLE REMEDY column requires work to be performed by specialist technicians or other authorised people who must always work using the Personal Protective Equipment indicated in the INSTALLATION manual. In some cases, this work can be performed by a normal operator. Installation Instructions

ERROR	PROBLEM	POSSIBLE SOLUTIONS
Black	Wheel balancer does not switch on	<ul style="list-style-type: none"> • Verify correct connection to the mains • Verify and eventually replace the fuses on the power card • Verify monitor function • Replace the computer board
Err. 1	No rotation signal	<ul style="list-style-type: none"> • Check in self-diagnostics that the encoder functions properly • Replace the phase pick-up board • Replace the computer board
Err. 2	Speed too low during detection During the unbalance measurement revolutions, the wheel speed has fallen to below 42 rpm	<ul style="list-style-type: none"> • Make sure that a vehicle wheel is mounted on the wheel balancer • Use the self-diagnostics function to check the encoder • Disconnect the piezo connectors from the board and do a spin (if no error is detected, replace the piezo sensors) • Replace the CPU board
Err. 3	Unbalance too high	<ul style="list-style-type: none"> • Verify wheel dimension settings • Check detection unit connections • Perform machine calibration • Mount a wheel with more or less known unbalance (less than 100 grams) and verify the response of the machine • Replace the computer board
Err. 4	Rotation in opposite direction After pressing [START], the wheel starts turning in the opposite direction (anticlockwise)	<ul style="list-style-type: none"> • Check in self-diagnostics that the encoder functions properly • Check the bearing/spring of the phase generator
Err. 5	Guard open	<ul style="list-style-type: none"> • Reset the error • Close the guard • Verify the function of the protection Switch
Err. 7/ Err. 8/ Err. 9	NOVRAM parameter read error	<ul style="list-style-type: none"> • Switch off the machine and wait for at least ~ 1 min.; re-start the machine and check it works properly • Repeat machine calibration • Replace the computer board

Err.11	Speed too high error During unbalance measurement rotation, wheel speed is more than 270 rpm	<ul style="list-style-type: none"> • Check in self-diagnostics that the encoder functions properly • Replace the computer board
Err. 14 Err.15/ Err.16/ Err.17/ Err.18/ Err.19/	Unbalance measurement error	<ul style="list-style-type: none"> • Check in self-diagnostics that the encoder functions properly • Check detection unit connections • Verify machine earth/ground connection • Mount a wheel with more or less known unbalance (less than 100g) and verify the response of the machine • Replace the computer board
Err. 20	Wheel still. The wheel must remain still for more than one second after START	<ul style="list-style-type: none"> • Use the self-diagnostics function to check the encoder • Check the connections on the power board • Replace the computer board
Err. 21	Motor on for more than 15 seconds	<ul style="list-style-type: none"> • Use the self-diagnostics function to check the encoder • Check the connections on the power board • Replace the computer board
Err. 23	Wheel positioning in proximity of the correction position error	<ul style="list-style-type: none"> • Check in self-diagnostics that the encoder functions properly • Check that there are no impediments to the rotation of the wheel
Err. 24	Pressing the STOP button during the measurement spin	<ul style="list-style-type: none"> • Check that the panel functions properly • Do not press the STOP button during the measurement spin
Err.230/ 238	Operating touch monitor errors	<ul style="list-style-type: none"> • Restart the balancing machine • Calibrate the touch monitor • Check touch monitor connections • Replace the touch monitor
Err. 240	Machine setting error	<ul style="list-style-type: none"> • Execute the initialization function
Err. 241	Estimated width dimension	<ul style="list-style-type: none"> • Manually set the correct rim width value before calibrating the machine
Unbalance incorrect with back centering cones	Mount the wheel in vertical position and push the sleeve up against the wheel. If necessary, repeat locking/unlocking/locking and perform the procedure again	<ul style="list-style-type: none"> • Mount the wheel in vertical position and push the sleeve up against the wheel. If necessary, repeat locking/unlocking/locking and perform the procedure again.

Installation Instructions

A factory trained COATS® Service Technician must perform the install, setup, and initial test procedures on your wheel balancer. Do not attempt to install and setup the unit yourself. Accurate and reliable operation of your unit depends on proper installation. Please contact COATS® directly at 1-800-688-9240 for the Certified Service Partner nearest you.

Receiving

The shipment should be thoroughly inspected as soon as it is received. The signed bill of lading is acknowledgement, for the carrier, of receipt in good condition of the shipment covered by our invoice.

If any of the goods called for on this bill of lading are shorted or damaged, do not accept them until the carrier makes a notation of the shorted or damaged goods on the freight bill. Do this for your own protection.

NOTIFY THE CARRIER AT ONCE if any hidden loss or damage is discovered after receipt and request him to make an inspection. If the carrier will not do so, prepare an affidavit to the effect that you have so notified the carrier (on a certain date) and that he has failed to comply with your request.

IT IS DIFFICULT TO COLLECT FOR LOSS OR DAMAGE AFTER YOU HAVE GIVEN THE CARRIER A CLEAR RECEIPT.

File your claim with the carrier promptly. Support your claim with copies of the bill of lading, freight bill, invoice, and photographs, if possible.

Although COATS responsibility ceases upon delivery of the shipment to the carrier, we will gladly assist in tracing lost shipments. Our willingness to assist in every possible manner does not make COATS responsible for collection of claims, or replacement of lost or damaged materials.

Standard Accessories

- Built-in Weight Tray
- 3 Back Cones (A, B, C)
- Truck Cone (D)
- Hub Nut
- Pressure Cup
- Rim Width Calipers

Features

- Balances Most Automotive Wheels
- Single-Spin Dynamic Two-Plane or Static Balancing
- Vertical Wheel Mounting
- Back Cone and Front Cone Mounting
- “No Bolt-Down” Installation
- Scratch Resistant Control Panel
- Easy-To-Read LEDs and Displays
- Automatic Calibration
- Removable Shaft Stud
- Automatic Rim Gauge Return
- Dynamic, Static, and Alloy Operating Modes

Specifications

- Weight (excluding adapter) 130 lbs.
- Single-phase power supply 115V, 50/60 Hz, 3A
- Protection class IP 54
- Max power consumption 0.8 Kw
- Balancing speed 100 rpm⁻¹
- Cycle time for average wheel (14 kg) 6-8 seconds
- Max. resolution of measurement 0.10 oz
- Position resolution ± 1.4 °
- Average noise < 70dB (A)
- Rim-machine distance 0 - 252 mm
- Rim width setting range 1.5 to 20 inches
- Diameter setting range 10 to 30 inches

Electrical Requirements

See serial tag for the appropriate power requirements of your machine.

Always have a qualified electrician install the proper receptacles in accordance with state and local codes.

Floor and Space Requirements

The balancer must be located on a flat floor of solid construction, preferably concrete. The balancer must sit solidly on its three feet. If the balancer is not level, does not sit solidly on its three feet, or is placed on an unstable floor, the balancer will not function properly and may produce inaccurate balance readings.

Do not operate the balancer while it is on the pallet.

Select a location for the balancer that provides a level, solid floor, and adequate clearance around and above the balancer. Make sure the location selected has enough room above and behind the unit so the hood can be raised completely. The location must also provide working room for mounting and removing wheels. Make sure the area has adequate lighting

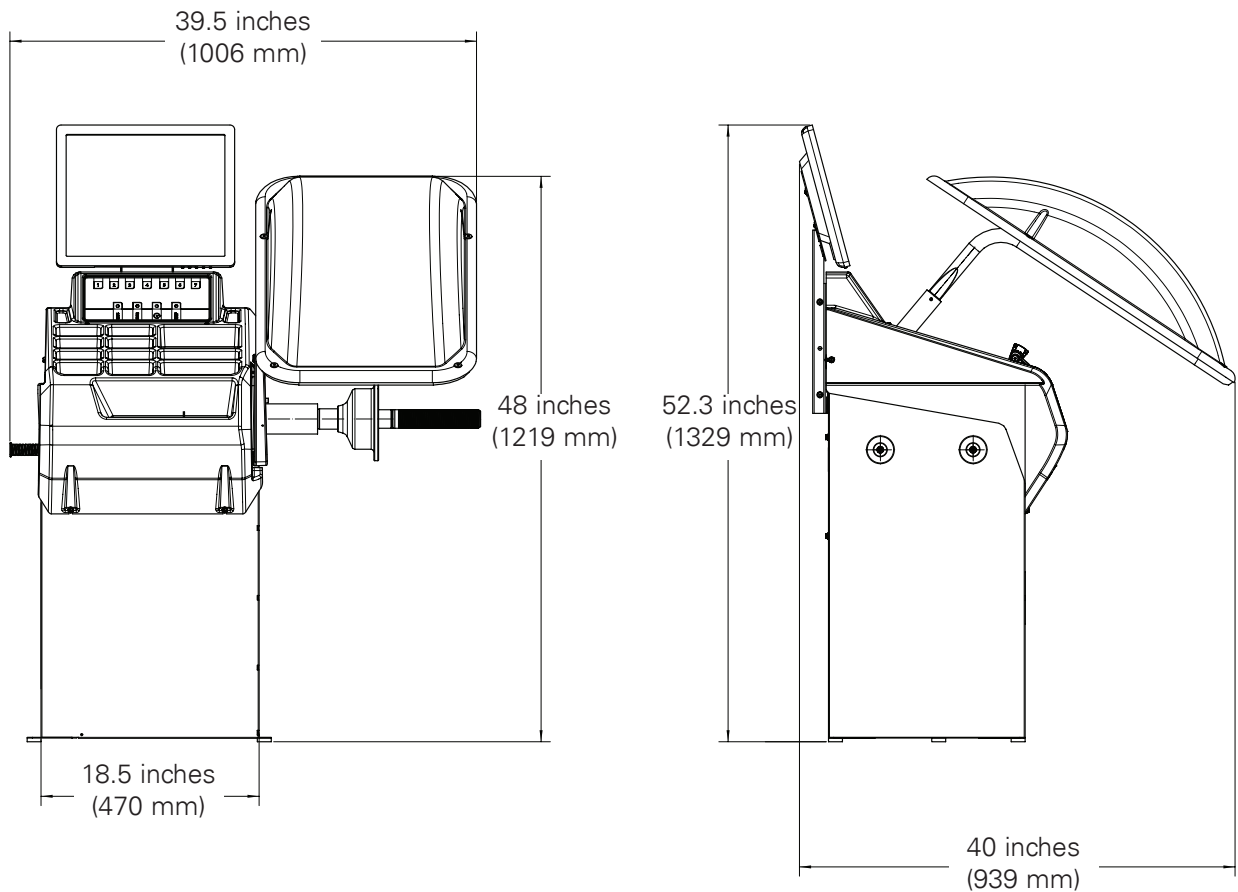

Space Requirements

Unpacking the Unit

1. Remove the shipping carton from the pallet. Fig. 1
2. Remove all loose parts and accessories packed around the unit. Remove Balancer from Pallet
3. Remove the shipping bolts that hold the balancer to the pallet.



Do not use the control panel, control panel base, accessory storage, faceplate, hood or shaft to lift the balancer.



Use help to remove the balancer from the pallet. The unit is heavy and the weight is not evenly distributed. Dropping the unit may cause personal injury or equipment damage.

4. Lift the balancer off the pallet and place it in its operating location.

Hood Installation

5. Remove one screw holding the Hood bracket to the balancer arm. Fig. 2
6. Align the Hood bracket with the balancer arm and secure with three screws. Fig. 3 & 4

Connect to Power

Your factory trained COATS® Service Technician should do the final check to verify the power installation before connecting the balancer to a power supply. Failure due to improper power connection may void the warranty.

Initial Testing

1. Plug the unit into an appropriate power outlet. If the circuit breaker for the outlet is off, turn it on.
2. Turn the balancer on. The power switch is on the back of the unit.
3. Test the hood switch with the auto spin feature to ensure proper installation. If problems check the height of the hood switch button for proper operation

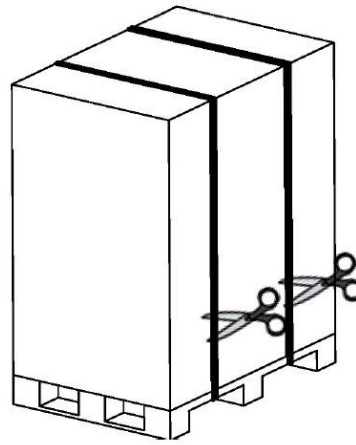

Fig. 1

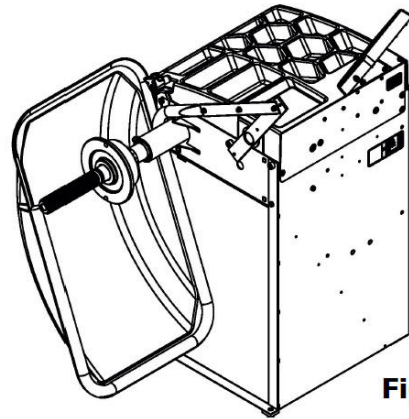

Fig. 2

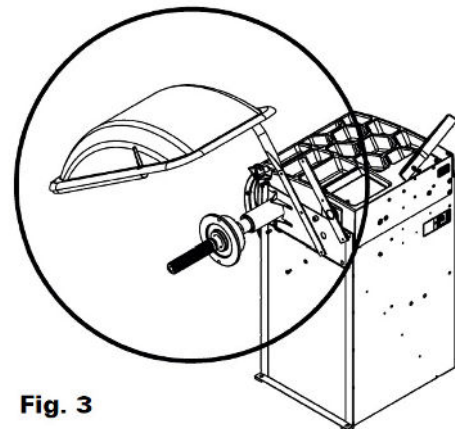

Fig. 3

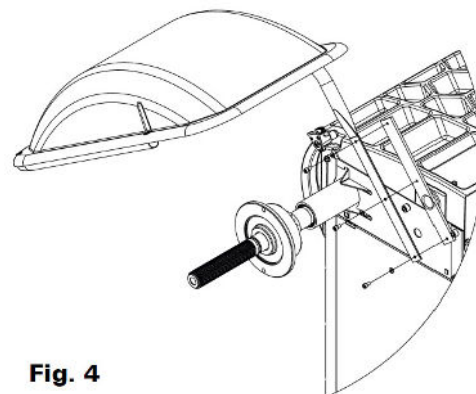

Fig. 4

Notes

Notes

Notes

