

GENERAL REPAIR

Complete Your Shop With
Coats® Equipment



4 POST
4 T415CSAR1 / 4T415CXAR1

“OPEN FRONT” 4 POST

WHEEL ALIGNMENT 15,000 LB.
/ 6.8T CAPACITY

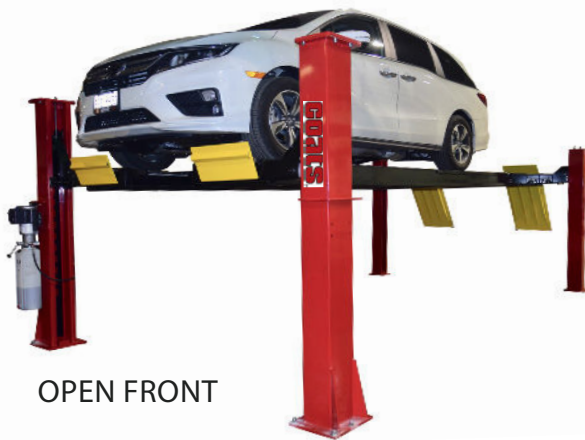

OPEN FRONT



4T415OSAR1/OXAR1

THE ONLY 4 POST WITH ADJUSTABLE FRONT
BEARINGS “CAMBER NEUTRAL” TECHNOLOGY

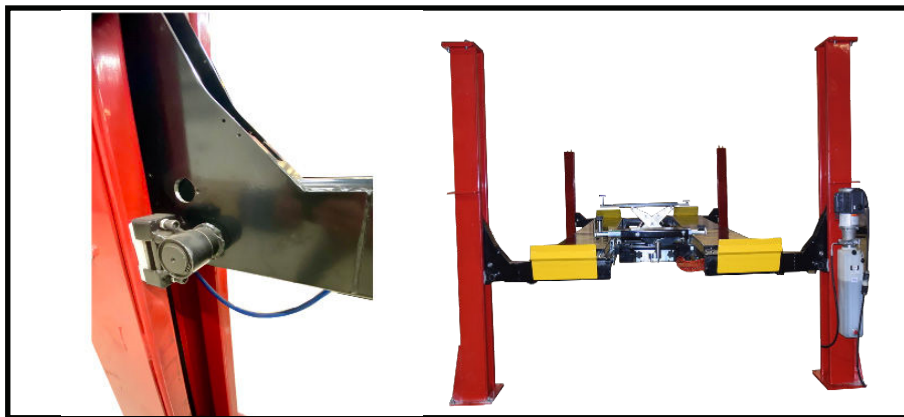

HEAVY DUTY 4 POST IDEAL FOR ALL GENERAL
SERVICE ON CARS & LIGHT TRUCKS

OPTIONAL ACCESSORIES



Heavy duty 7,500 lb. (3.4T) Jacking beam
4TRJ75HD 5 yr. parts warranty

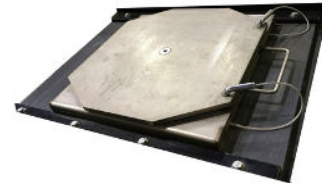

Stainless Steel Turnplates 4TSTP

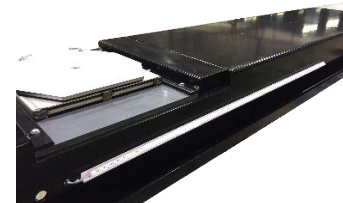

24V LED Lighting kit shuts off before
reaching the floor 4TLED



Built in runway tire inflation hoses with
pressure gauges 4TTIL

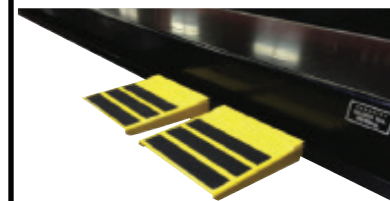

Removeable Runway Step Platforms with
non slip surface 4TMWS

4 POST ALIGNMENT 15,000 LB. / 6.8T CAPACITY

To learn more about the Coats 4 Post, or any of our
other quality products, contact your authorized
Coats distributor or call 1-855-876-3864 for the dealer
nearest you.

CONTACT US NOW

www.coatsgarage.com
or call 1-855-876-3864

COATS®

4 POST OPEN FRONT WHEEL
ALIGNMENT 15,000 LB. / 6.8T
CAPACITY



4T415OSAR1 / 4T415OXAR1



1. Machined 9" / 229mm Pulley & 1/2" / 12.3mm 6 x 36 cables

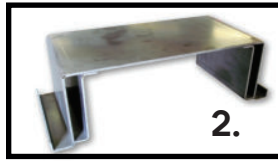

2. Double wall reinforced deck with Z rail

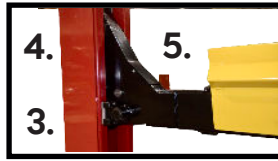

3. 4. OPEN FRONT "Camber Neutral" Adjustable front arms



6. 7. Air locking system with water trap/regulator filter standard

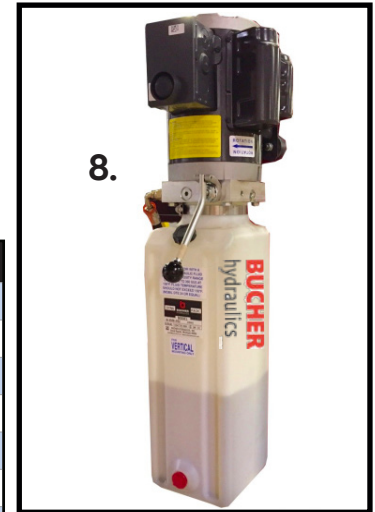

8.

Energy efficient US Made Bucher 2HP / 1.5kw power unit typically lasts the life of the lift - single point lock release

FEATURE	
1.	9" / 229mm steel pulleys with 1/2" / 12.3mm cables
2.	Wide 26" / 660 mm double wall non flex runways
3.	Optional "Open Front Design"
4.	Durable powder coat double bake finish
5.	Heavy Duty 3" x 8 1/4" / 74 - 210mm
6.	Water trap/ air regulator/ filter
7.	Single point air lock releases
8.	Premium US made Bucher Power Unit
9.	Open Runways with 7/8"/875mm plated slip plate balls
10.	Flip down/ up front wheel stops
	4" Diameter x 65" long / 102 x 1651 mm cylinder

BENEFITS	
1.	Last longer with less maintenance
2.	More stable platform for light & medium duty trucks
3.	Improved worker productivity
4.	Resists corrosion reduces & maintenance costs
5.	Less runway sagging & longer cable/pulley life
6.	Protects locking & jack system for lower maintenance cost
7.	Safer raising & lowering on the mechanical locking system
8.	Lasts longer with Less maintenance
9.	Easier to maintain reduces corrosion
10.	Allows for clear access when performing alignment
	Lasts longer with Less maintenance

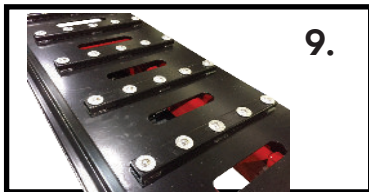

9. Open runway slots under rear slip plates

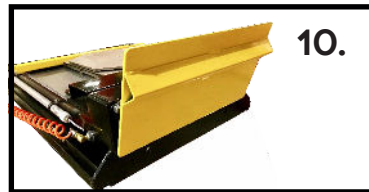

10. Flip down front wheel stops

EQUIPMENT FOOTPRINT

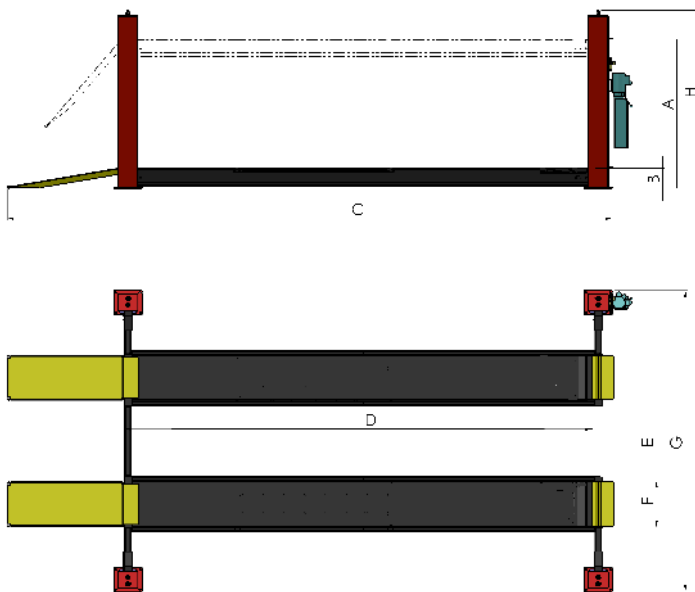

CATEGORY		OPEN FRONT 4 POST ALIGNMENT
	CAPACITY	15,000 lb. (6.8T)
A	RAISED HEIGHT	75" (1905mm)
B	LOWERED HEIGHT	8 3/8" (213mm)
C	OVERALL LENGTH EXTENDED	287 1/2" (7303mm)
C	OVERALL LENGTH STANDARD	260 1/2" (6617mm)
D	DECK LENGTH EXTENDED	238" (6045mm)
D	DECK LENGTH STANDARD	211" (5359mm)
E	WIDTH BETWEEN RUNWAYS	41" (1041mm)
F	RUNWAY DECK WIDTH	26" (660mm)
G	OVERALL WIDTH FRONT/REAR	137 1/2" (3493mm) front - 143" (3632mm) rear
H	MAX COLUMN HEIGHT	101 1/2" (2587mm) front - 86" (2184mm) rear
	MINIMUM & MAXIMUM 4 WHEEL ALIGNMENT	84" to 164" (2234 to 4178mm)
	MINIMUM MAXIMUM 2 WHEEL ALIGNMENT EXTENDED	209" (5309mm)
	MINIMUM MAXIMUM 2 WHEEL ALIGNMENT STANDARD	182" (4623mm)
	MAXIMUM WHEEL BASE VEHICLE EXTENDED	226" / 5055mm
	MAXIMUM WHEEL BASE VEHICLE STANDARD	199" / 5055mm
	LIFT TIME	70 seconds
	POWER REQUIREMENTS	230V - 60Hz - 1Ph - 25 amp
	JACKING BEAM CAPACITY	7,500 LB. (3.4T)
	SHIPPING WEIGHT	4450 - 4750 lb. (2030 - 2159 kg.)
	PART NUMBERS	4T415OSAR1/4T415OXAR1