

COATS®

Model H.I.T. 6000 TRUCK TIRE CHANGER

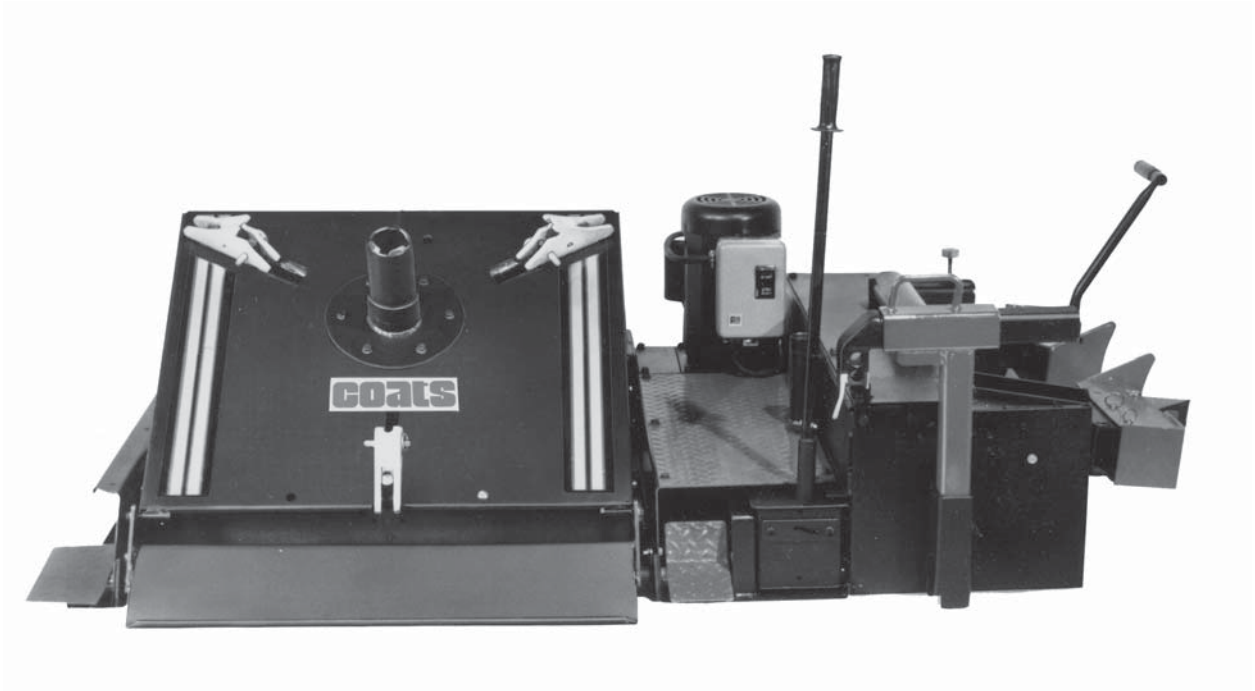

Safety Instructions Installation Instructions Operating Instructions Maintenance Instructions

READ these instructions before placing unit in service. KEEP these and other materials delivered with the unit in a binder near the machine for ease of reference by supervisors and operators.

HENNESSY INDUSTRIES, INC.

1601 J. P. Hennessy Drive, LaVergne, TN USA 37086 615/641-7533 800/688/6359 www.ammcoats.com
HENNESSY INDUSTRIES INC. Manufacturer of AMMCO®, COATS® and BADA® Automotive Service Equipment and Tools.

Manual Part No.: 8120583 03
Revision: 07/14

Table of Contents

Safety Instructions	1 - 2
Owner's Responsibility	1
Operator Protective Equipment	1
Definitions of Hazard Levels.....	1
Safety Instructions	2
Bead Loosening.....	2
Demounting & Mounting.....	2
Inflation	2
Installation Instructions	3 - 4
Electrical Installation	4
Air Installation	4
General.....	4
Principal Operating Parts	4
Operating Instructions	5 - 11
Tubeless Tire Bead Loosening.....	5 - 6
Multiple Piece Rim Bead Loosening	6
Clamping.....	6 - 7
Demounting	7 - 8
Mounting.....	8 - 9
Inflation	9
Special Instructions for "Duplex" or "Super Single" Tires	10
Mounting.....	11
Maintenance Instructions	12 -13

Safety Instructions



Failure to follow danger, warning, and caution instructions may lead to serious personal injury or death to operator or bystander or damage to property. Do not operate this machine until you read and understand all the dangers, warnings, and cautions in this manual. For additional copies of either, or further information, contact:

Hennessy Industries, Inc.

1601 J. P. Hennessy Drive
LaVergne, TN 37086
(615) 641-7533 or (800) 688-6359
www.ammcoats.com

Owner's Responsibility

To maintain machine and user safety, the responsibility of the owner is to read and follow these instructions:

- Follow all installation instructions.
- Make sure installation conforms to all applicable Local, State, and Federal Codes, Rules, and Regulations; such as State and Federal OSHA Regulations and Electrical Codes.
- Carefully check the unit for correct initial function.
- Read and follow the safety instructions. Keep them readily available for machine operators.
- Make certain all operators are properly trained, know how to safely and correctly operate the unit, and are properly supervised.
- Allow unit operation only with all parts in place and operating safely.
- Carefully inspect the unit on a regular basis and perform all maintenance as required.
- Service and maintain the unit only with authorized or approved replacement parts.
- Keep all instructions permanently with the unit and all decals/labels/notices on the unit clean and visible.
- Do not override safety features.

Operator Protective Equipment

Personal protective equipment helps make tire servicing safer. However, equipment does not take the place of safe operating practices. Always wear durable work clothing during tire service activity. Loose fitting clothing should be avoided. Tight fitting leather gloves are recommended to protect operator's hands when handling worn tires and wheels. Sturdy leather work shoes with steel toes and oil resistant soles should be used by tire service personnel to help prevent injury in typical shop activities. Eye protection is essential during tire service activity. Safety glasses with side shields, goggles, or face shields are acceptable. Back belts provide support during lifting activities and are also helpful in providing operator protection. Consideration should also be given to the use of hearing protection if tire service activity is performed in an enclosed area, or if noise levels are high.

Definitions of Hazard Levels

Identify the hazard levels used in this manual with the following definitions and signal words:

DANGER

Watch for this symbol:



It Means: Immediate hazards, which will result in severe personal injury or death.

WARNING

Watch for this symbol:



It Means: Hazards or unsafe practices, which could result in severe personal injury or death.

CAUTION

Watch for this symbol:



It Means: Hazards or unsafe practices, which may result in minor personal injury or product or property damage.



Watch for this symbol! It means BE ALERT! Your safety, or the safety of others, is involved!

Safety Instructions



Only properly trained personnel should service tires on the H.I.T. 6000. Read all safety and operation instructions thoroughly before using the tire changer.

ALWAYS remove all wheel weights and the valve core to deflate the tire before servicing.

ALWAYS cover the electric motor and switch box before hosing down the tire changer. Be sure water does not enter the motor or switch box.

ALWAYS disconnect the electric power and air supply before attempting any maintenance.

ALWAYS keep all working surfaces clean and free of tire lube buildup.

ALWAYS be aware of what each person is and will do before attempting any two-person operation.

Bead Loosening

NEVER place anything between the bead loosener disc and the tire/wheel.

NEVER place any part of your body between the bead loosener disc and the tire/wheel, severe bodily injury may result.

NEVER allow the bead loosener to contact the wheel, wheel damage may occur.

Demounting & Mounting

NEVER stand on the working table while demounting or mounting a tire.

ALWAYS keep hands, feet, and other objects away from moving parts while the machine is turned on.

ALWAYS place the narrow bead seat to the outside when clamping. Failure to demount the tire from the narrow bead seat side may cause damage to the tire beads.

ALWAYS apply an approved rubber lubricant to rim flanges and both tire beads before demounting or mounting and seating the beads. *NEVER* use antifreeze, silicone, or petroleum base lubricants.

ALWAYS clean and inspect the wheel.

NEVER mount a tire on a damaged or rusty wheel. Wheel damage or rust may cause tire or wheel failure during inflation. Explosion from failure may result in severe injury or death of the operator and bystanders.

ALWAYS be sure the bead opposite the tool is in the drop center before rotating the tire when demounting or mounting to avoid damage to the tire beads.

Inflation

ALWAYS follow all applicable Local, State, and Federal Codes, Rules, and Regulations; such as the Federal OSHA Standard Number 1910.177.

NEVER seat beads or inflate a tire on the tire changer. The H.I.T. 6000 is not designed as a safety device or stand for bead seating or inflation.

ALWAYS use an approved inflation chamber or inflation cage.

The following safety instructions are for one piece wheels only. Refer to the manufacturer's or R.M.A. procedures for multi-piece wheels.

ALWAYS use an approved inflation chamber or inflation cage equipped with a grip chuck and a remote inflation gauge and valve. **DO NOT OVER INFLATE!** Tire or wheel failure during and after inflation may result in an explosion capable of causing severe injury or death.

ALWAYS inflate the tire to manufacturer's recommended cold operating pressure.

NEVER reinflate a tire that has been run under-inflated or flat without first demounting the tire and checking for wheel and tire damage.

ALWAYS inspect the tire interior for loose or broken cords, cuts, penetrating objects, and other damage to the carcass. Discard tires that cannot be properly repaired.

NEVER rework, weld, heat or braze wheels.

NEVER strike the tire or wheel with a hammer.

ALWAYS be sure the tire diameter exactly matches the wheel diameter.



Tire failure under pressure can be hazardous. Place the wheel inside an approved inflation chamber or cage before inflating. Use an approved remote inflation valve, hose, and gauge. ALWAYS wear safety goggles for eye protection. Do not stand beside the wheel or cage during inflation. Keep hands and other parts of the body out of the cage during inflation. Observe the tire pressure frequently. Do not exceed the manufacturer's recommended maximum inflation pressure. Failure to follow these instructions may cause the tire and rim to separate with tremendous force, resulting in serious personal injury or death.

Installation Instructions

Parts Box Check List

Ref.	Name	Part No.	Qty.	Assembly Instructions
0	Fastener Package	7120393	1	Contains the following: nuts, bolts, pins, and screws
	Detent Pins	7120326	5	B.L. shoes and stop connections
	1/4 x 1/2" Cap Screw	7105390	1	B.L. pedal assembly
	1/4" Locknut NC	7000591	2	B.L. pedal & handle connection
	3/8 x 3/4" Self-Tap Bolt	7106300	4	Fastener bead lifter holder
	1/4 x 1-1/4" Cap Screw	7120321	1	Secures PN 8120391 handle
	Breather Cap	7120291	1	Switch with solid cap in reservoir
	Quick Coupler-Female Fit.	7120440	1	To be used on owners air supply connection to machine air inlet
1	B.L. Shoe W/C	7120112	1	Install with (2) PN 7120326 detent pins
2	B.L. Rim Stop	7120513	1	Install with (1) PN 7120326 detent pins
3	Pivotal Shoe Assy.	7120545	1	Install with (2) PN 7120326 detent pins
4	B.L. Pedal Assy.	7120396	1	Attach to pedal extension with (1) PN 7105390 1/4 x 1-1/2" cap screw and (1) PN 7000591 1/4" lock nut
5	Bead Lifter Holder	7120328	1	Can be installed in two positions, see diagram. Secure with (4) PN 7106300 3/8 x 3/4" self tapping bolts
6	Bead Lifter Tool	7120332	1	Insert in bead lifter holder
7	Handle	7120391	1	Fits over valve shaft. Secure with (1) 1/4 x 1-1/4" NC screw & 1/4" lock nut
8	Lube Bottle	7120347	1	Place in bracket on top of B.L. cover
9	Hold Down-Lube Bottle	7120346	1	Place over lube bottle "v" down. Bottom of "v" must be located over holes in bracket.
10	Spring	7101106	2	Hook to hold down and bracket on B.L. cover
11	Swab	7120366	1	Place in lube bottle (Note: Fill lube bottle with approved lubricant)

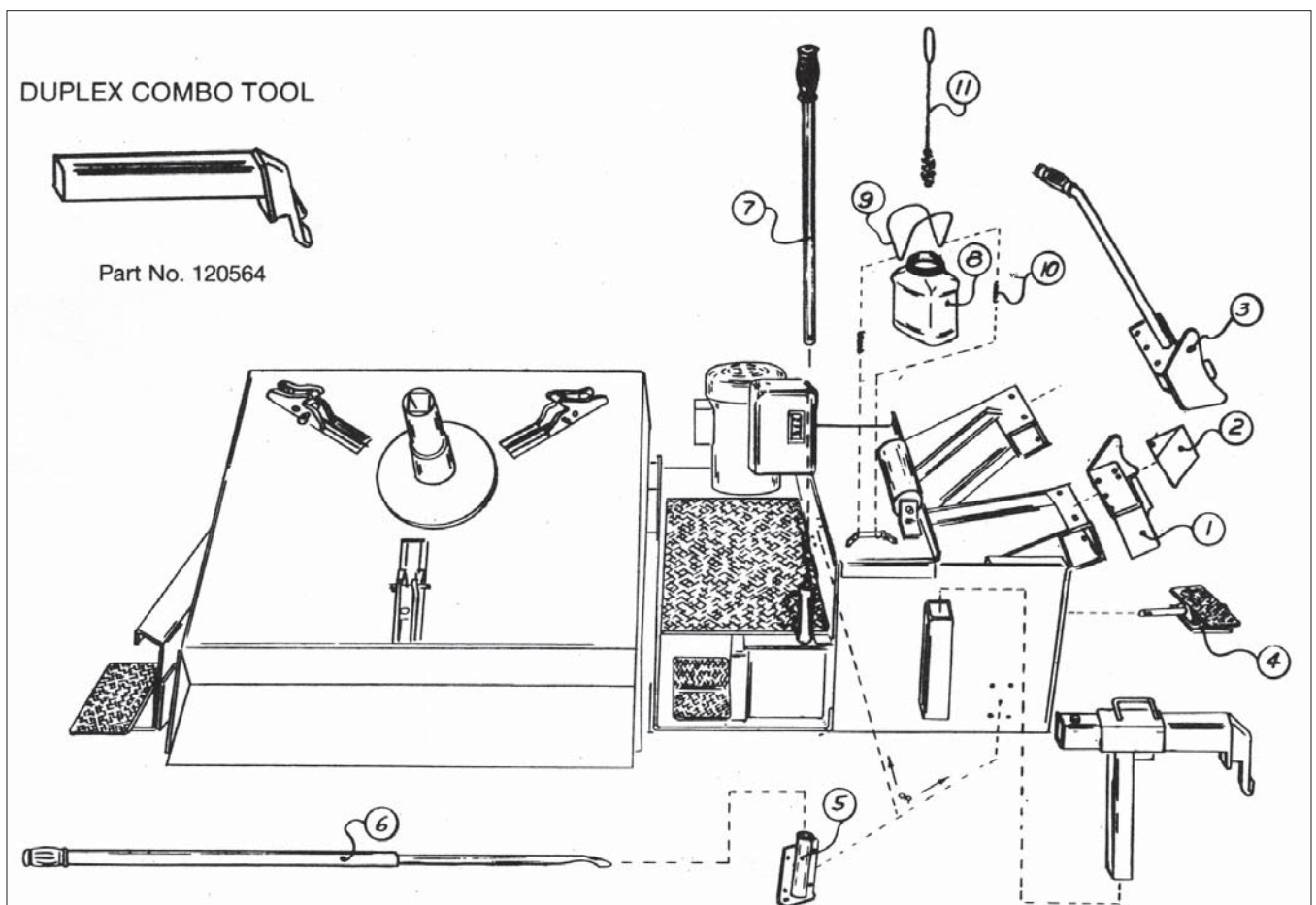

Electrical Installation

The H.I.T. 6000 requires 220 volt, 3 phase or optional single phase power source. **CAUTION:** Only a licensed electrician should install power source and hook up the H.I.T. 6000.

Important: Installation of this unit in an area where gasoline, gasoline fumes, or other flammable vapors are present requires a motor/switch riser kit (PN 7120433) to meet national electrical codes; including paragraphs 500-4, 501 (1-8), 511 (1-5), PP 70-377.

Disconnect power source and check with volt-ohm meter to assure power is off before connecting wires of machine.

Air Installation

A quick coupler is provided for disconnecting the air supply during maintenance procedures. The male fitting is on the inset hose. The female is in the parts bag for installation on the owner's air supply hose.

For lubrication of internal air system, a lubricator should be installed in the air supply line.

General

The H.I.T. 6000 does not require bolting to the floor. However, if desired, the two holes located at the back of the machine, used for mounting on the pallet, should be used. **DO NOT BOLT AT THE FRONT OF THE MACHINE.**

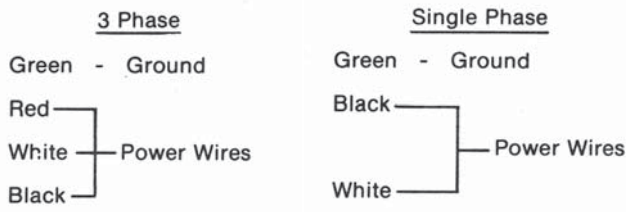

Motor rotation must be clockwise looking at top of motor. If counterclockwise, reverse any two of the power wires.

Principal Operating Parts

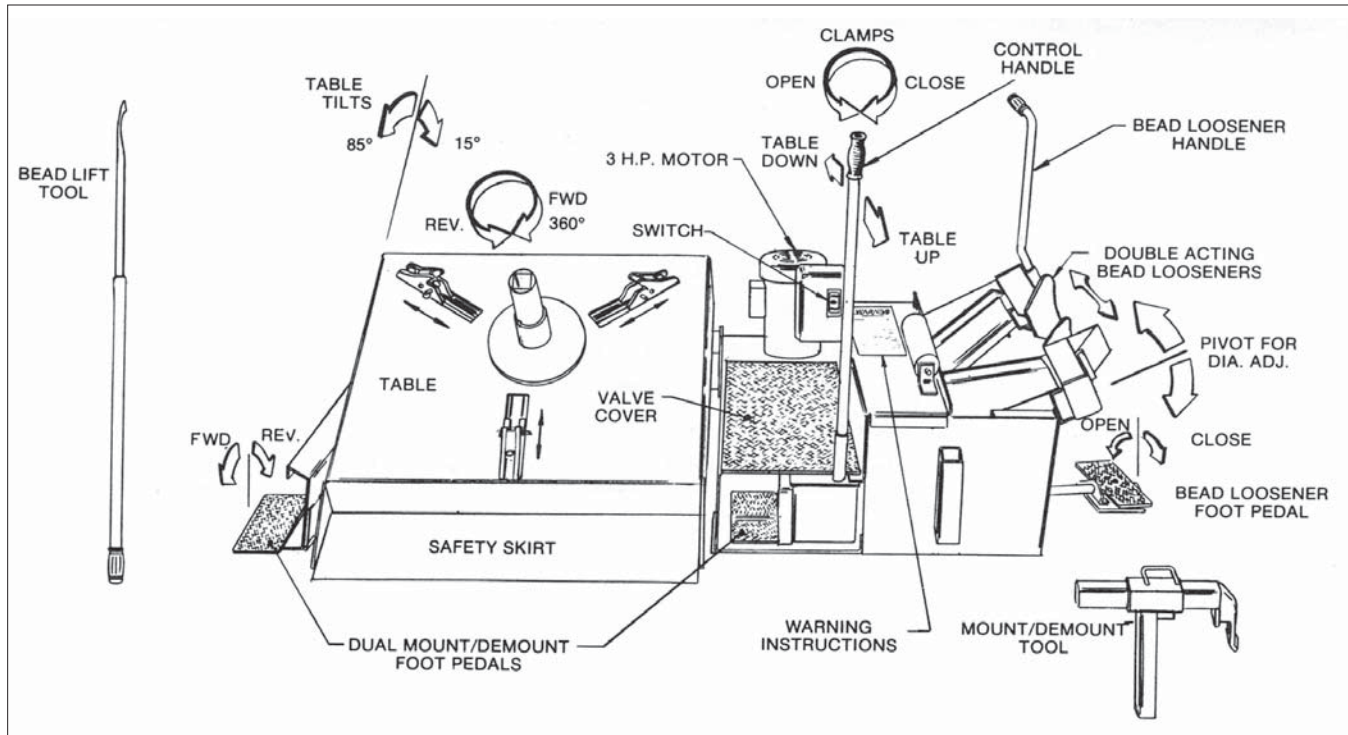

Operating Instructions

Tubeless Tire Bead Loosening

Remove the valve core and allow tire to deflate completely. Remove all weights from wheel.

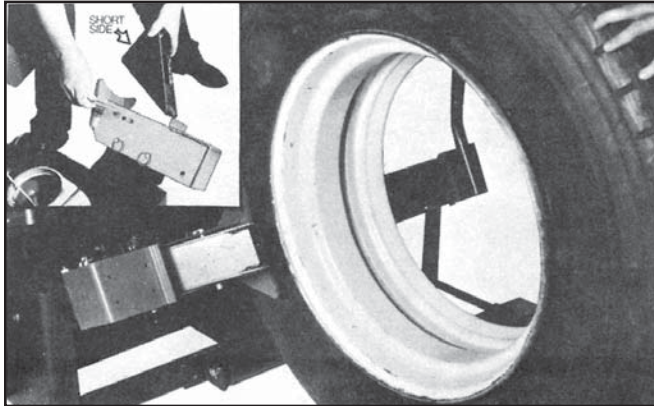

1. Install rim stop in the appropriate position for tubeless tires. See illustration.

Position tire between bead loosener shoes: short drop center side toward shoe with rim stop.



Do not place any part of body between bead loosening shoes while machine is running.

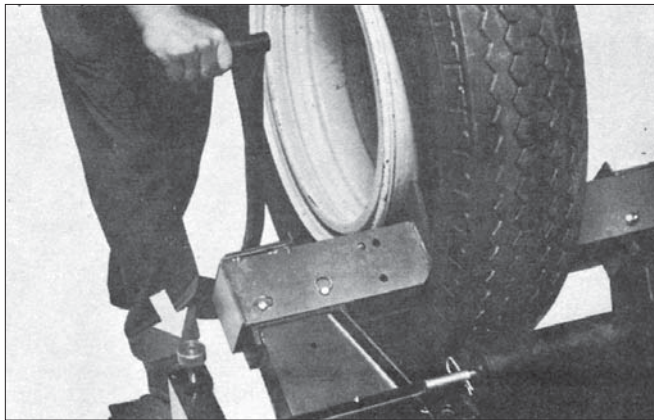

2. Adjust shoes and loosen beads: using handle, adjust bead loosener shoes on tire sidewalls 1/4-inch from rim contour. Depress left side of foot pedal to loosen beads. Depress right side to retract shoes. Note: for handling several wheels of the same size, an adjustable stop is provided for convenience. (See arrow.)



Never allow both bead loosening shoes to contact rim, since this could cause rim damage.

3. For most tires, one operation of the bead loosener shoes will loosen both beads. However, some difficult tires on rusty rims may require an additional operation to loosen the second bead. Here are three methods that can help loosen the second bead.



Spin Wheel: Retract shoes completely. Roll wheel back, spin 180 degrees and loosen opposite side as in step 2 above.

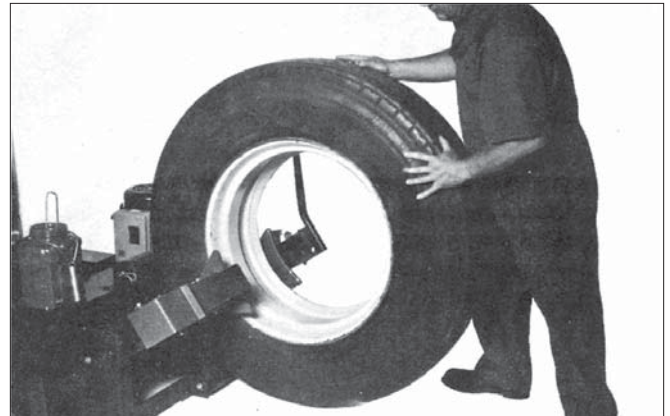

Roll Wheel: Retract shoes completely. Roll wheel forward firmly against the rollers and rotate it to a new position. Reposition and loosen bead as in step 2 above.

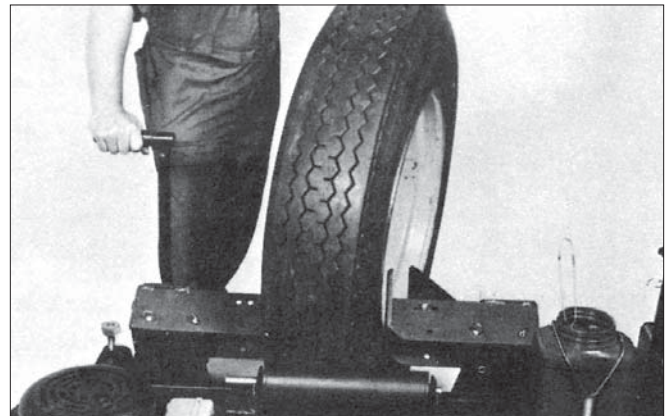

Angle Tire: (not recommended for aluminum rims) The shoe with the rim stop may itself be used as a rim stop. Angle the wheel so that this shoe contracts the rim and the opposite shoe contacts the unloosened bead.

WARNING

Allowing both shoes or one shoe and the rim stop to contact the rim during bead loosening may cause rim damage.

Multiple Piece Rim Bead Loosening

CAUTION

Before attempting to loosen beads, remove the valve core and be sure the tire is completely deflated. Do not place any part of the body between bead loosener shoes.

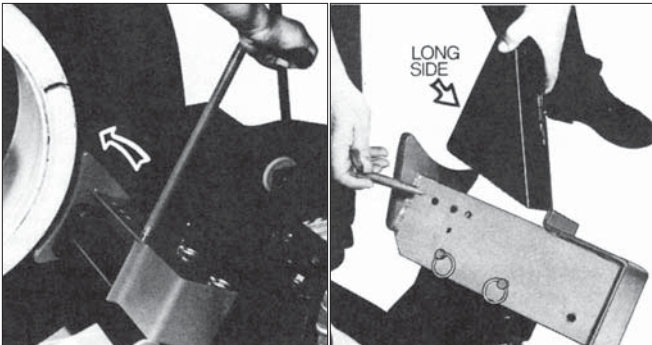

1. Place rim stop in tube type tire position; see illustration.

2. Position tire between bead loosener shoes with the ring(s) toward the kicker shoe.

Position bead loosener shoe with 1/4" of lock ring.

CAUTION

Do not let shoes push on rim or lock ring(s). Rim or rings may become warped and damaged.

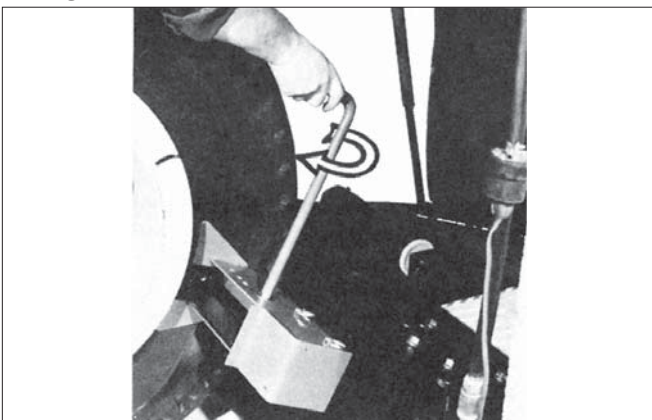

3. Actuate bead loosener so that the bead loosener shoe pushes bead in. As the kicker shoe passes the ring, pull handle to bring the kicker shoe up to the bead. Continue to full stroke of bead loosener.

4. Disengage bead loosener shoes and turn tire 90 degrees and repeat steps 1, 2, & 3 until bead is loosened.

5. Use bead loosener shoes to hold tire and remove lock ring.

6. To loosen other bead, remove wheel assembly from between the shoes and pivot tire 180 degrees to position the ring side of the wheel near rim stop. Repeat steps 2, 3, and 4 above.

WARNING

Always inflate tires inside a safety inflation cage. Tire explosion during inflation can cause serious injury or death.

Clamping

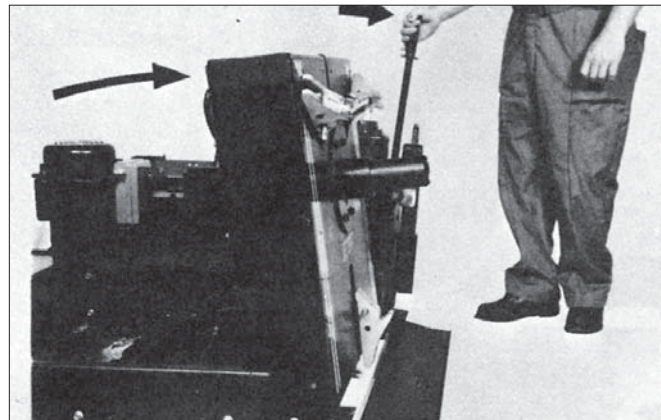

1. Raise working table: Raise working table to almost vertical position by pulling back on the control handle. Open clamps by twisting the control handle counter-clockwise.



2. Clamp Adjustment: Adjust all three clamps to the proper wheel diameter range. The front hole position is for 19.5" to 24.5". The rear hole position is for 16" to 19.5".

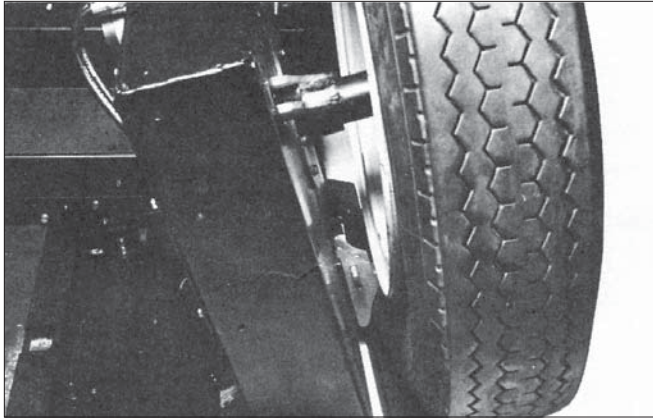

3. Position Wheel: Roll wheel onto the safety skirt as close to the working top as possible. Position rim flange into the lower clamp.

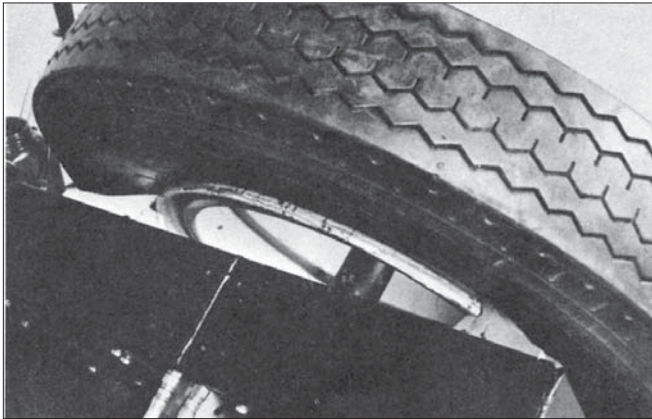

4. Clamp Rim: With the left hand on the top front of the rim, push the rim toward the upper two clamps. Then close the clamping jaws by twisting the control handle clockwise. Observe the clamping action to make sure all three clamps are properly engaged. Lower working table to desired angle by pushing forward on control handle.



Make sure the short drop center side of the wheel is toward the operator. Attempting to demount tire from the long drop center side may damage the tire bead.

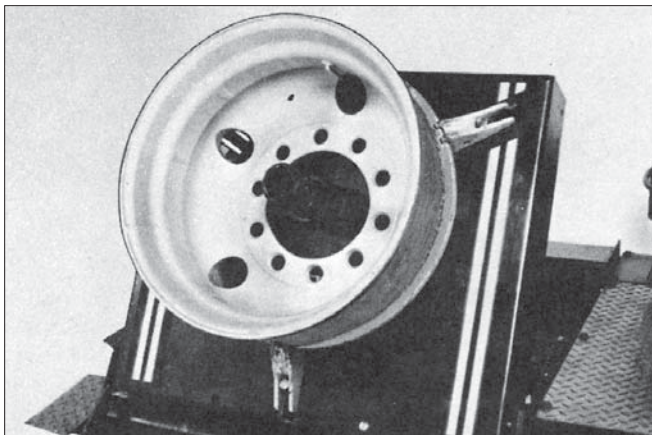

Aluminum Wheels: Many aluminum wheels are designed for the tire to be mounted from either side. For these wheels it is recommended to clamp with the disc side down. However, if the wheel does have a short drop center side, it should always be clamped with this side up.

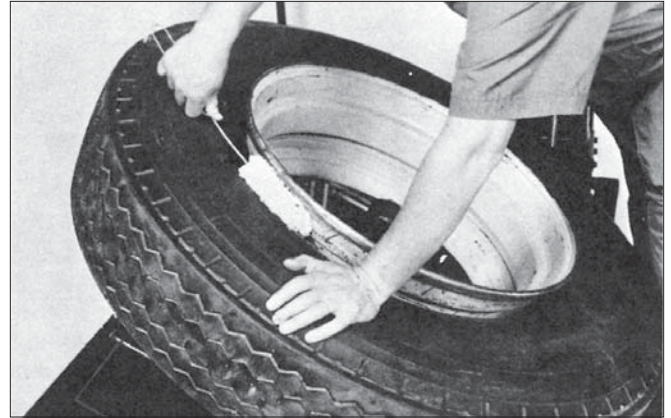

5. Lubricate both beads thoroughly: Both beads and the rim flange should be thoroughly lubricated with an approved tire lubricant before attempting to demount the tire. It may be easier to lubricate the bottom bead while the tire is in the bead loosener.

Demounting

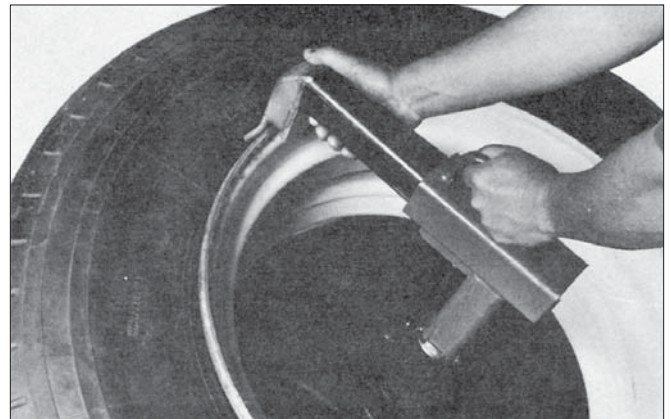

1. Install Mount/demount Tool: Insert mount/demount tool in square drive socket and position tool head on the rim flange. Rotate the tool head to approximately a 12 o'clock position by depressing either foot pedal.

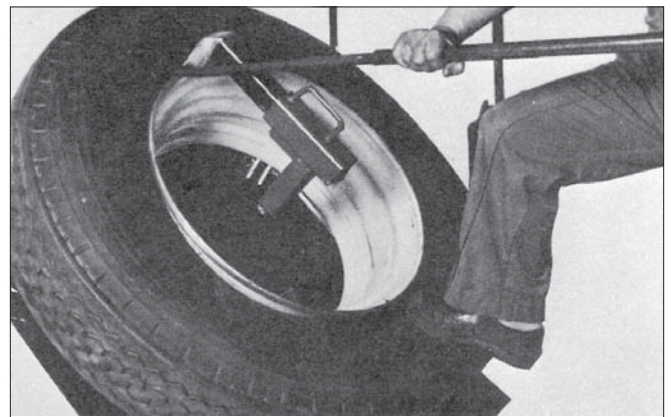

2. Lift Top Bead: Insert bead lifter under top bead to left of mount/demount tool and lift bead over lower blade of the tool head. Note: Make sure the top bead at the 6 o'clock position is in drop center.

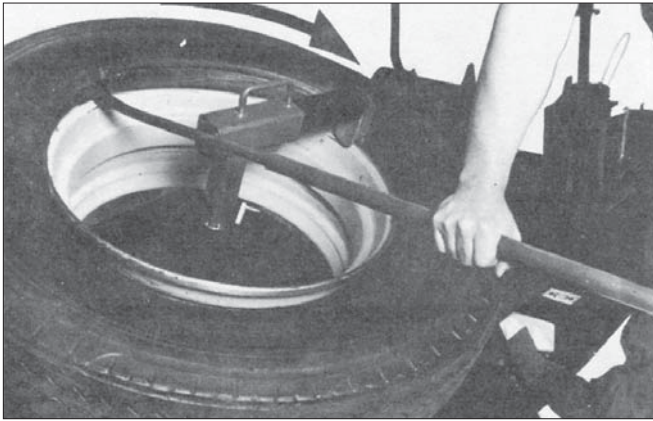

3. Demount Top Bead: Holding the bead lifter down as shown, depress the front side of either foot pedal thus rotating the tool head clockwise and demounting the top bead. Make sure mount/demount tool does not rotate into bead lifter during the operation.

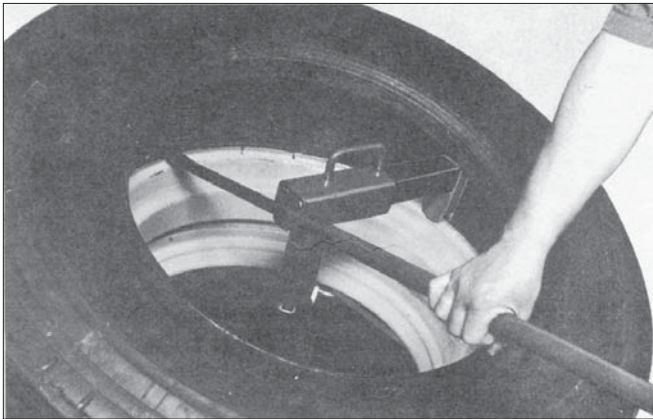

4. Demount Bottom Bead: Return mount/demount tool to the 12 o'clock position and insert bead lifter under bottom bead to the left of head. Again, make sure the opposite side of the bottom bead goes into drop center. Lift bottom bead over tool blade. Hold the bead lifter mount/demount tool clockwise and demounting bead. Make sure tool does not rotate into bead lifter during the operation.



Always demount by rotating tool clockwise.

5. Remove Tire: The demounted tire can now be removed. On heavier tires raising the working table will help lift the tire to a vertical position.

Mounting

1. Before mounting tire on a used rim, be sure flange area (particularly the bead seat area) is clean and smooth. Remove any buildup of rust, corrosion or old rubber with wire brush.



Never mount a tire on a rim where any parts show cracks, damage, or have been repaired by welding or brazing. Thoroughly inspect inside of casing for damage or foreign material. Make sure that the tire is completely dry, as moisture deteriorates the cord fabric of the tire and may result in eventual failure of the tire. Lubricate both beads with an approved rubber lubricant. Never use silicones, anti-freeze, or petroleum base solutions.

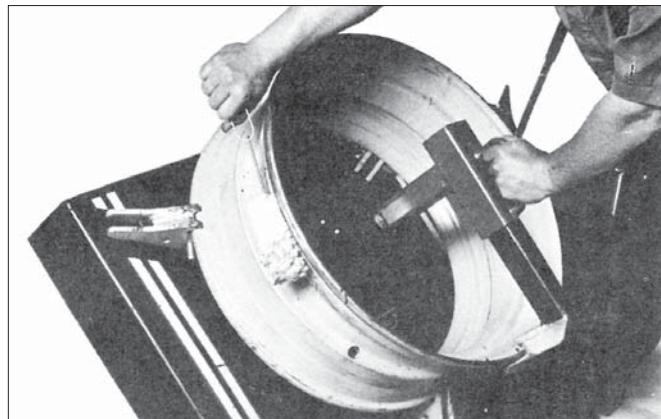

2. Lubricate Rim: After inspecting rim, thoroughly lubricate both bead seats with approved tire lubricant.

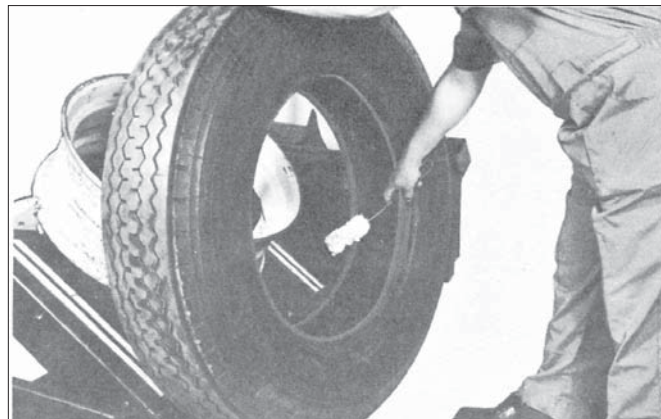

3. Lubricate Tire Beads: After inspecting tire thoroughly, lubricate both beads inside and out with an approved lubricant.

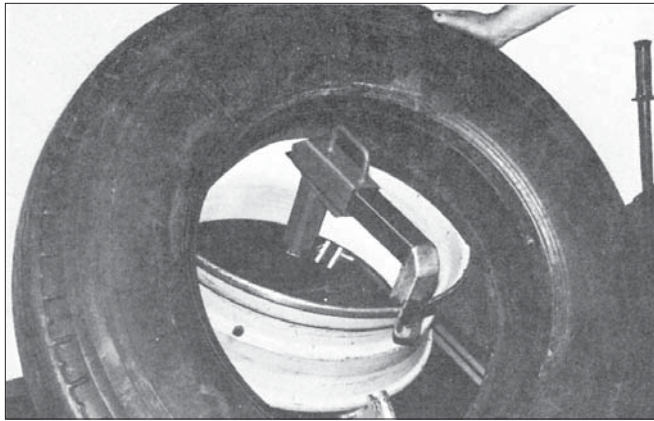

4. Position Tire: Lower table to a comfortable angle and rotate tool to approximately the 7 o'clock position. Lean tire over the rim and hook lower bead on mount/demount tool handle.

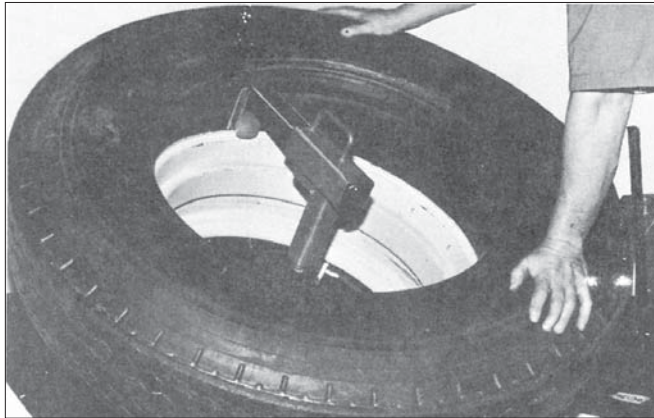

5. Mount Bottom Bead: Depress front of either foot pedal, thus rotating the tool clockwise. Hold down on the tire until the tool begins to mount the bottom bead. Make sure the bead goes into drop center behind the tool head.



Keep hands away from the tire beads and tool head during operation.

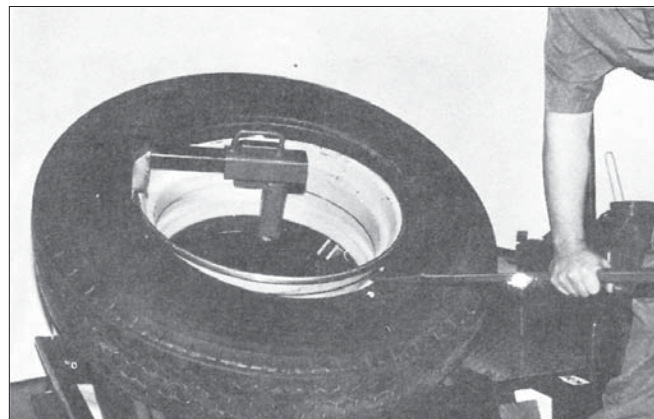

6. Mount Top Bead: With tool head at approximately the 7 o'clock position, push top bead over tool head and hold bead into rim drop center with the bead lifter as shown. Depress front of right foot pedal, thus rotating

tool clockwise and mounting the top bead. Make sure that the bead following the tool keeps sliding into drop center as the tool rotates.



Never inflate tire on the H.I.T. 6000. It is not intended as a safety device for inflation. Always use an approved safety cage.

7. Remove Wheel: Remove mount/demount tool from drive socket. If tool appears jammed, reverse the tool slightly by depressing the back of either foot pedal. Raise working table and release clamps by twisting control handle counter-clockwise.

Inflation

These instructions are for tubeless one piece rim wheels only. Follow tire manufacturer's or RMA recommended procedures for multi piece rims.



Do not attempt to inflate tire on the tire changer. It is not intended as a restraining or safety device for inflation.

Always use approved safety cage and safety procedures.

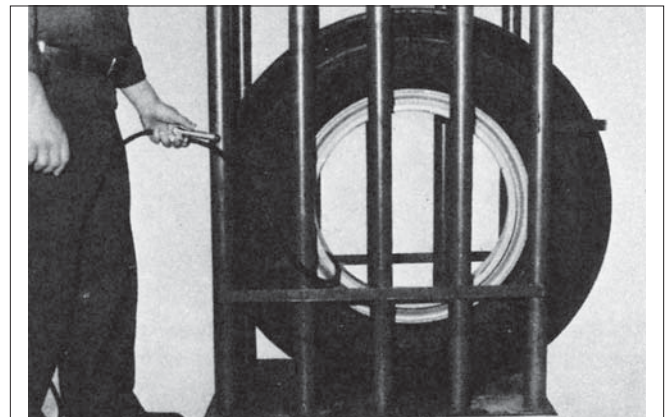

Tire failure under pressure can be hazardous, place wheel completely inside an approved safety cage before inflating. Use an approved remote inflation valve, hose and gauge. Wear safety goggles for eye protection. Do not stand beside wheel or cage during inflation. Observe pressure frequently and do not exceed the tire's recommended maximum inflation pressure. Failure to follow these instructions can cause tire or rim to separate with tremendous force and can lead to serious personal injury or death.

Special Instructions for "Duplex" or "Super Single" Tires

Wheel Preparation: Remove valve core and allow tire to deflate completely. Remove all wheel weights.

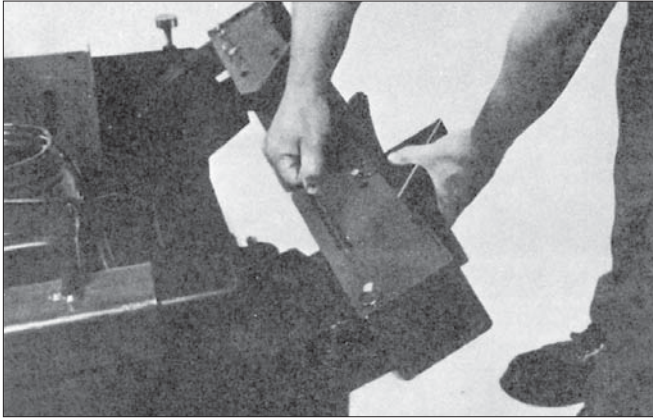

1. Adjust Bead Loosener Shoes: For tire width of 10" and over, one or both bead loosening shoes should be adjusted.

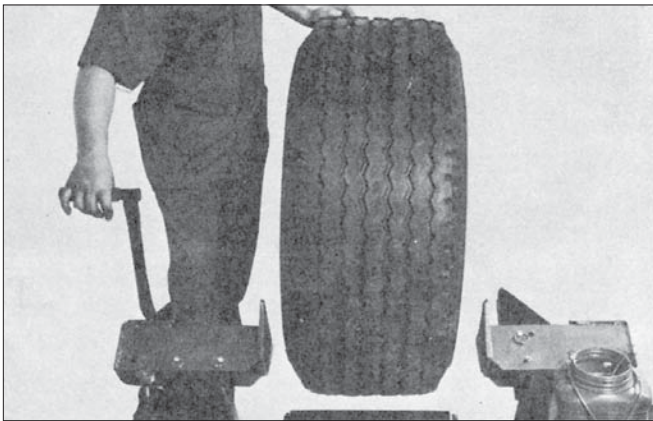

2. Position tire and loosen beads as explained in the bead loosening section.

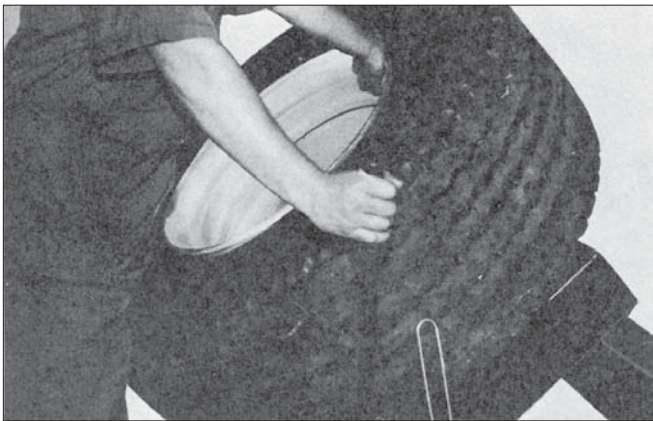

3. Clamping: Due to the stiff sidewall, it may be necessary to push down on the rim at the top as the clamps are being closed, to engage the rim. Lowering the table slightly will let the wheel's weight help in clamping.

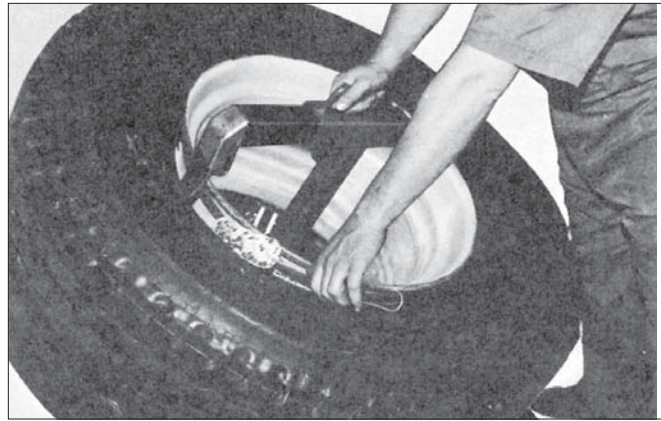

4. Lubricate tire beads and rim flange thoroughly: It may be easier to lubricate the top bead by letting the mount/demount tool push down on the bead and then rotating the tool with the lube swab following the tool. Demount the top bead in the usual manner). See section one.

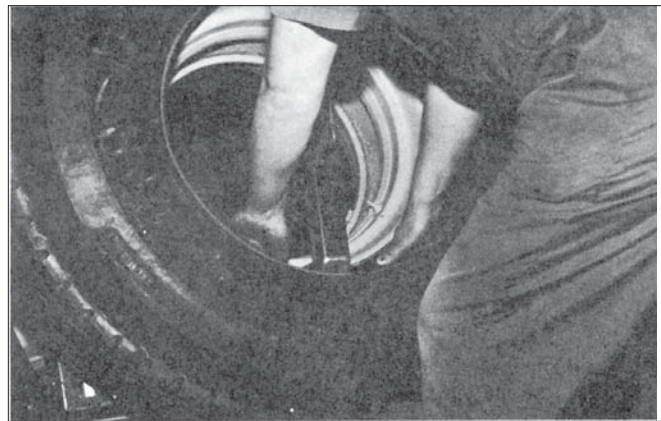

5. Position Tire: It will be necessary to get the bottom bead into drop center by raising the working table to almost vertical (do not allow the tire to touch floor). Pull out on tire as shown until bottom bead moves into drop center. Then raise working table until tire rests on floor to hold it in drop center.

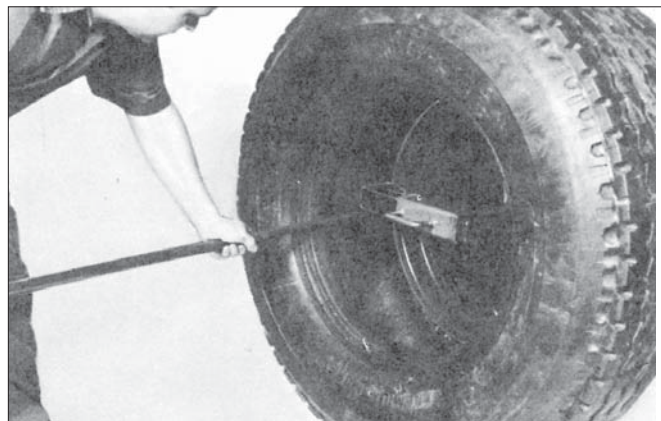

6. Insert Bead Lifter: With bottom bead in drop center and tire resting on the floor, rotate tool to 9 o'clock position and insert bead lifter under bottom bead just below the tool head.

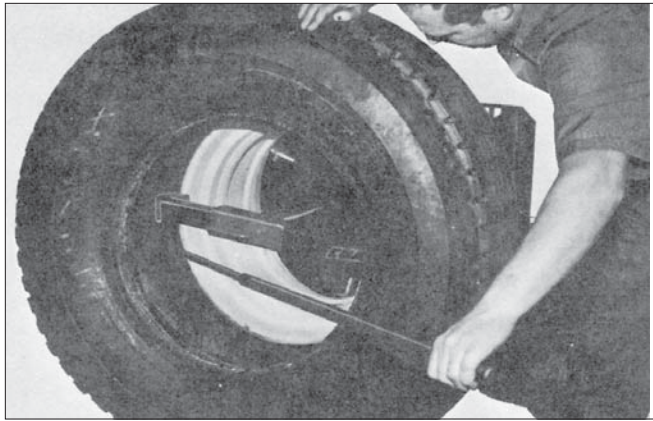

7. Demount Bottom Bead: Lift bead over mount/demount head. Rotate tool clockwise to demount bottom bead.



8. Remove Tire: After demounting the bottom bead, lower table to free rim from tire.

Mounting



1. Mount Bottom Bead: With the table at a comfortable angle, mount the bottom bead in the usual manner. It may be necessary to lift the bottom bead into drop center as the mount/demount tool rotates.

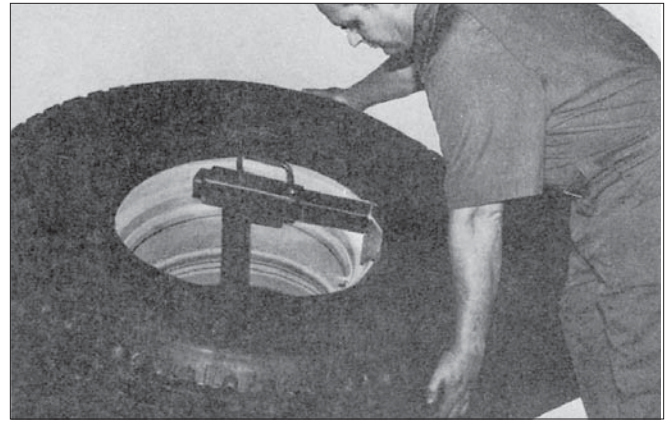

2. Position Top Bead: Manipulate and position the tire so that the bottom bead slips down toward its bead seat and the top bead rests evenly around the upper rim flange.

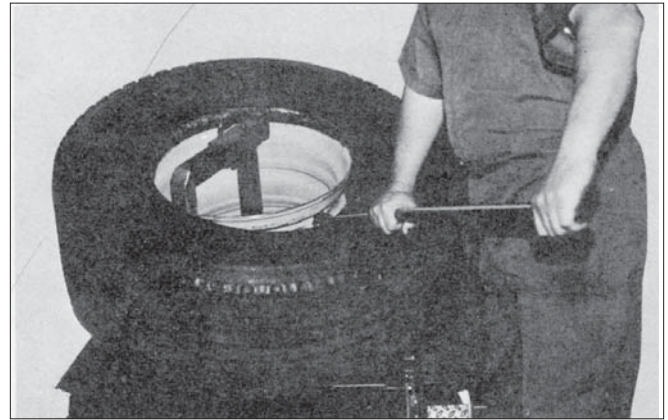

3. Mount Top Bead: Use bead lifter to hold top bead into drop center while tool rotates.



Never inflate tire or seat beads while on the tire changer. It is not intended as a safety device for inflation. Always use an approved safety cage for tire inflation.

Maintenance



Before attempting any maintenance, disconnect electrical power and air supply.

OPERATION	DAILY	2 WKS	2 MOS	6 MOS
1. CHECK RESERVOIR OIL- USE COATS HYDRAULIC OIL	X			
2. LUBRICATE PEDAL SHAFTS- USE SPRAY LUBRICANT		X		
3. PUT OIL IN AIR LINES- USE SPRAY LUBRICANT		X		
4. PUT OIL ON BEAD LOOSENER TUBE-USE HYDRAULIC OIL		X		
5. LUBRICATE CLAMP CARRIERS- USE AGMA #1 OR #2 GREASE			X	
6. LUBRICATE RING GEAR- USE AGMA #1 OR #2 GREASE				X
7. CHANGE OIL FILTER-USE SERVICE PART NO. 120222				X

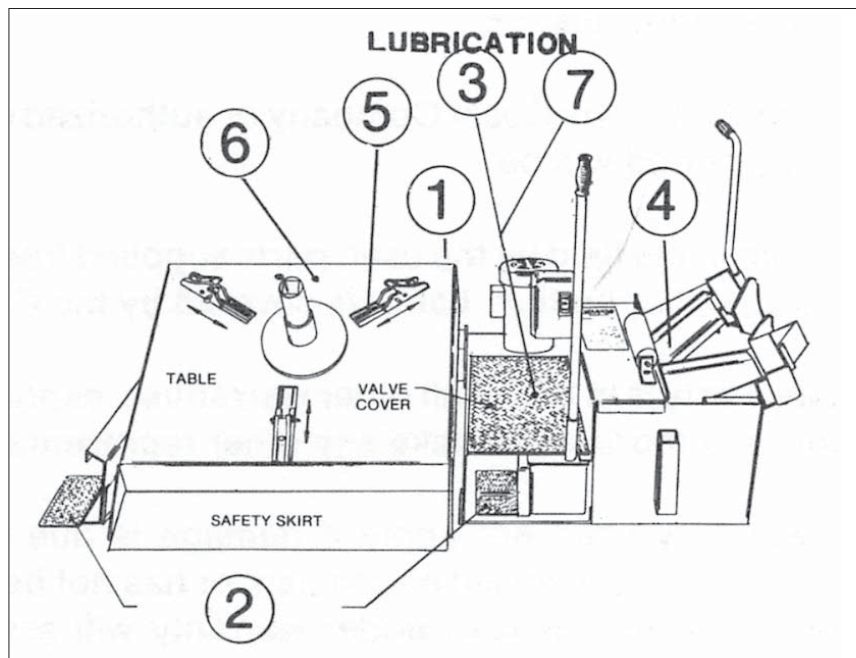

CAUTION

Loss of power and/or excessive pump noise indicates low oil. Shut off machine immediately or damage to pump and motor will result. Damage resulting from insufficient oil is not covered under warranty.

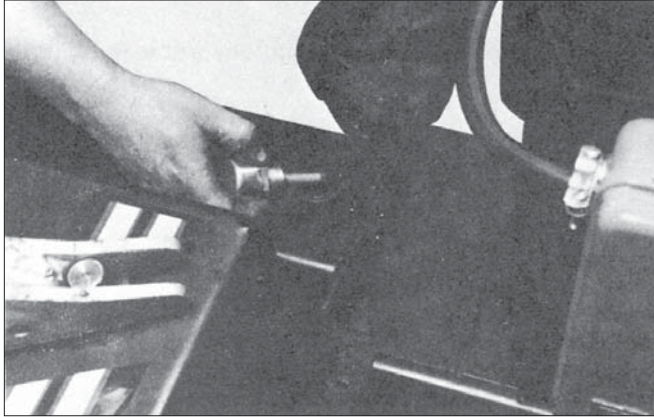

1. Oil Level Check: Remove filler cap and check oil level on dip stick. Fill to proper level as needed. Use hydraulic oil only.

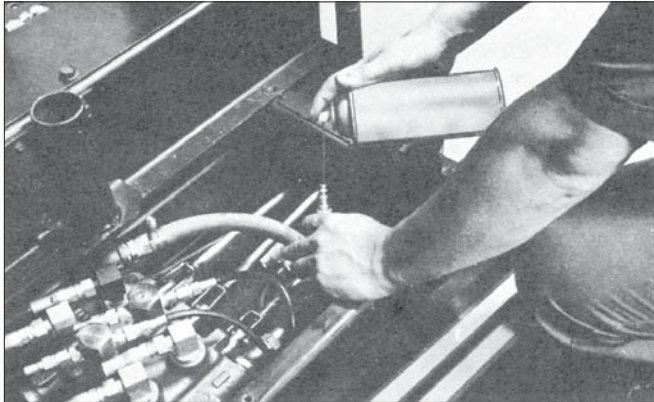

3. Oil Air Lines: Disconnect air supply at rear of machine. Remove cover plate and disconnect quick coupler connection between air valve and cylinder. Use fair amount of spray lubricant.

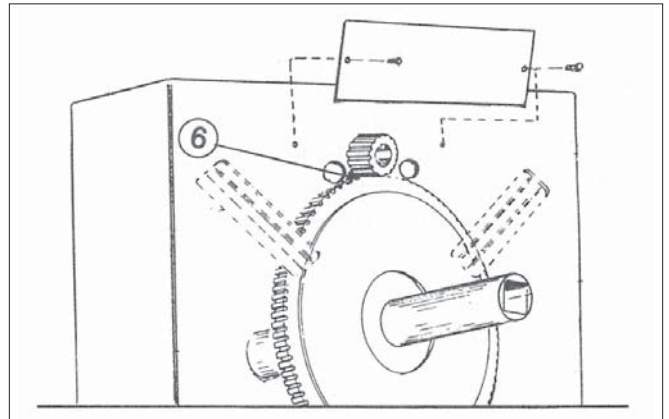

6. Lubricate Ring Gear: To gain access to the pinion and ring gear, remove the COATS name plate located on the working table. With a small brush or grease gun, apply AGMA #1 or #2 grease liberally on the ring gear teeth.

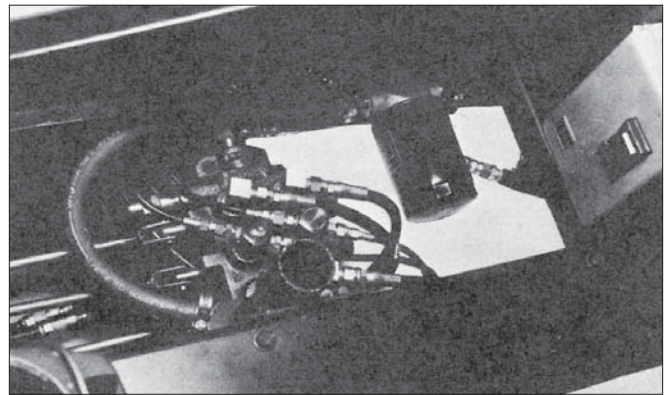

7. Oil Filter Change: Disconnect electrical power. Remove cover panel and place a shallow pan under oil filter. Remove oil filter with standard auto oil filter grip or wrench. Replace with service part #8120222.

