

COATS®

9024

Rim Clamp® Tire Changer

For servicing single piece automotive and most light truck tire/wheel assemblies

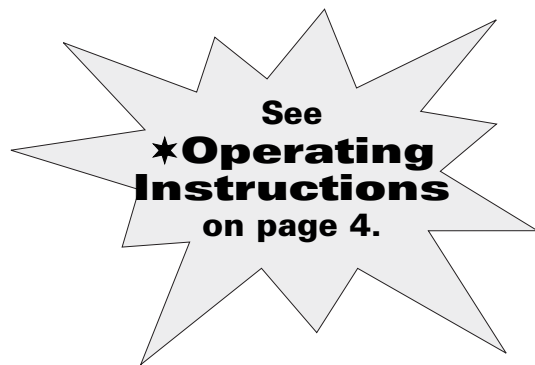

Installation Instructions Operating Instructions Safety Instructions Maintenance Instructions

READ these instructions before placing unit in service KEEP these and other materials delivered with the unit in a binder near the machine for ease of reference by supervisors and operators.

HENNESSY INDUSTRIES, INC.

1601 J. P. Hennessy Drive, LaVergne, TN USA 37086-3565 615/641-7533 800/688-6359

HENNESSY INDUSTRIES INC. Manufacturer of AMMCO®, COATS® and BADA® Automotive Service Equipment and Tools.

Manual Part No.: 8184377 02

Revision: 01/07

Safety Instructions

Owner's Responsibility

To maintain machine and user safety, the responsibility of the owner is to read and follow these instructions:

- Follow all installation instructions.
- Make sure installation conforms to all applicable Local, State, and Federal Codes, Rules, and Regulations; such as State and Federal OSHA Regulations and Electrical Codes.
- Carefully check the unit for correct initial function.
- Read and follow the safety instructions. Keep them readily available for machine operators.
- Make certain all operators are properly trained, know how to safely and correctly operate the unit, and are properly supervised.
- Allow unit operation only with all parts in place and operating safely.
- Carefully inspect the unit on a regular basis and perform all maintenance as required.
- Service and maintain the unit only with authorized or approved replacement parts.
- Keep all instructions permanently with the unit and all decals/labels/notices on the unit clean and visible.
- Do not override safety features.

Operator Protective Equipment

Personal protective equipment helps make tire servicing safer. However, equipment does not take the place of safe operating practices. Always wear durable work clothing during tire service activity. Loose fitting clothing should be avoided. Tight fitting leather gloves are recommended to protect operator's hands when handling worn tires and wheels. Sturdy leather work shoes with steel toes and oil resistant soles should be used by tire service personnel to help prevent injury in typical shop activities. Eye protection is essential during tire service activity. Safety glasses with side shields, goggles, or face shields are acceptable. Back belts provide support during lifting activities and are also helpful in providing operator protection. Consideration should also be given to the use of hearing protection if tire service activity is performed in an enclosed area, or if noise levels are high.

Definitions of Hazard Levels

Identify the hazard levels used in this manual with the following definitions and signal words:

DANGER

Watch for this symbol:



It Means: Immediate hazards, which will result in severe personal injury or death.

WARNING

Watch for this symbol:



It Means: Hazards or unsafe practices, which could result in severe personal injury or death.

CAUTION

Watch for this symbol:



It Means: Hazards or unsafe practices, which may result in minor personal injury or product or property damage.



Watch for this symbol! It means BE ALERT! Your safety, or the safety of others, is involved!

Safety Notices and Decals



Failure to follow danger, warning, and caution instructions may lead to serious personal injury or death to operator or bystander or damage to property. Do not operate this machine until you read and understand all the dangers, warnings and cautions in this manual. For additional copies of either, or further information, contact:

Hennessy Industries, Inc.

1601 J.P. Hennessy Drive
LaVergne, TN 37086-3565
(615) 641-7533 or (800) 688-6359
www.ammcoats.com

For additional information contact:

Rubber Manufacturers Association

1400 K Street N. W.
Washington, DC 20005
(202) 682-4800

Tire Guides, Inc.

The Tire Information Center
1101-6 South Rogers Circle
Boca Raton, FL 33487-2795
(561) 997-9229
www.tireguides.com

Remember R.I.M.

Three Simple Steps To Help Keep Shops Safe

READ | INSPECT | MOUNT

R.I.M. is a training program developed by Hennessy Industries to help keep tire technicians safe. By following the basic principles of R.I.M., technicians can avoid situations that can cause catastrophic accidents like tire explosions.

R.I.M. stands for read, inspect, and mount:

Read the tire size on a new tire before mounting to make sure it is the proper size for the wheel.

Inspect the wheel for cracks, rust, and or other damage that could cause an unsafe situation.

Mount the tire safely, making sure not to put any part of your body over the tire during inflation.

The most serious of possible accidents is a tire explosion. This is often caused by a tire/rim mismatch.

If a tire explodes on a tire changer, pressure causes it to fly straight up at tremendous speed. If a technician is standing over the tire, he can be seriously injured or killed.

Hennessy's R.I.M. program allows the technician to avoid situations that can cause tire explosions and other accidents. The full program, including training videos, brochures, posters, and other materials, is available from Coats distributors nationwide.



For more details, contact your Coats distributor or e-mail us.

Table of Contents

Safety Instructionsiii
Owner’s Responsibilityiii
Operator Protective Equipmentiii
Definitions of Hazard Levelsiii
Safety Notices and Decalsiv
Remember R.I.M.iv

Principle Operating Parts2 - 3
Know Your Unit2-3

Operating Instructions4 - 8
Bead Loosening and Demounting4 - 7
Mounting7 - 8

Inflation9 - 11
Bead Sealing10
Bead Seating10
Inflation11

**Stages of Inflation on a Conventional Tire
and Rim12**



Mismatched Tires and Wheels13

**Performance, Custom, and Aluminum
Wheels14 - 18**
Performance Tires & Wheels • Demounting . .14 - 16
Performance Tires & Wheels • Mounting . . .17 - 18

Custom and Special Wheels18

Maintenance Instructions19 - 21
Separator/Lubricator Maintenance20
Mount/Demount Head Cleaning20
Pressure Limiter Maintenance20 - 21

Installation Instructions21
Location21
Air Source21
Electrical Source21

	 NOTICE
	Read entire manual before assembling, installing, operating, or servicing this equipment.

Principal Operating Parts



Do It Now!

Now is a good time to fill out the Owner's Registry Card.

Know Your Unit

Compare this illustration with the unit before placing it into service. Maximum performance and safety will be obtained only when all persons using the unit are fully trained in its parts and operation. Each user should learn the function and location, of all controls.

Prevent accidents and injuries by ensuring the unit is properly installed, operated and maintained.

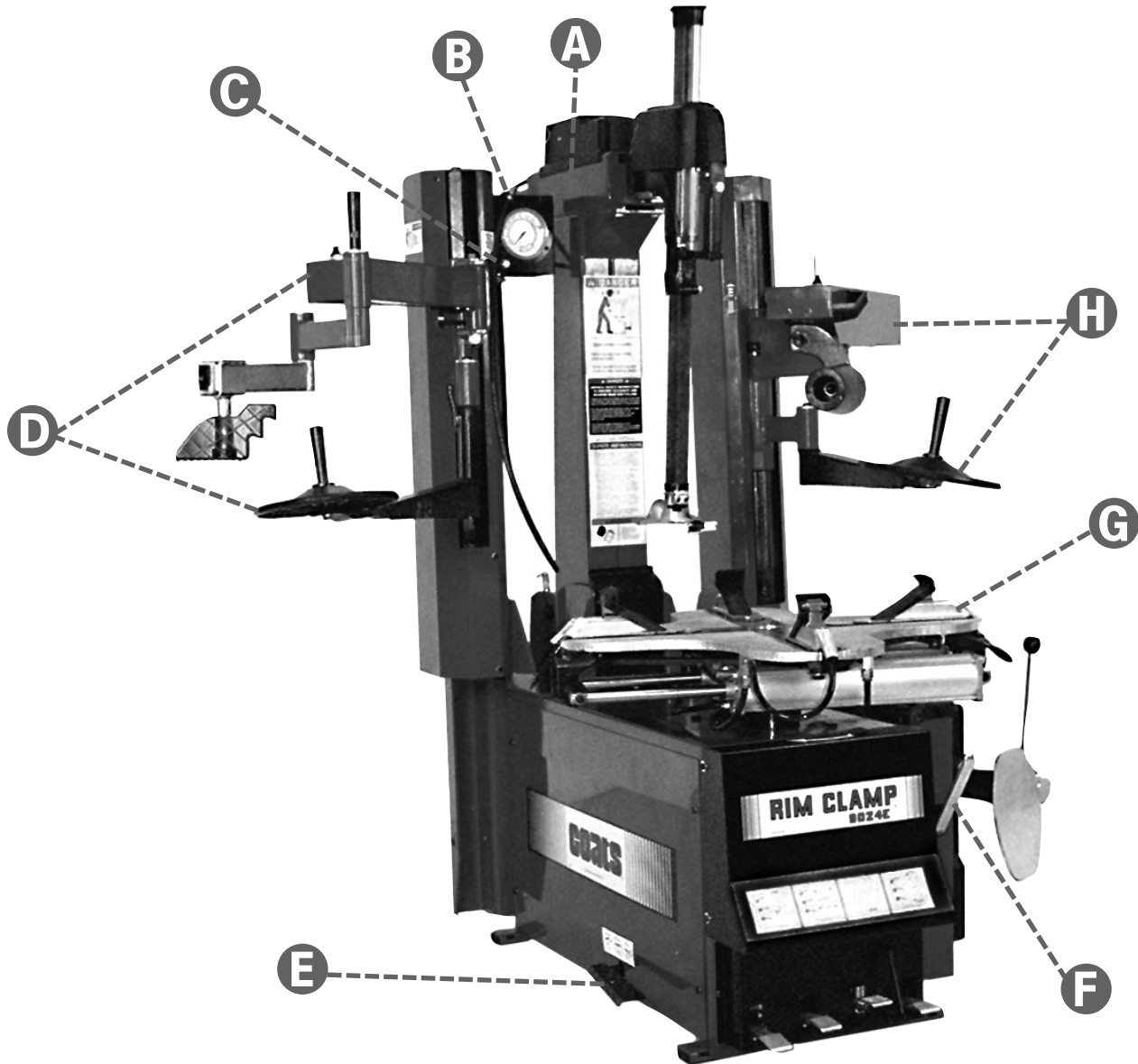

- A Tower** — Support for horizontal and vertical slides.
- B Air Inflation Gauge** — Registers tire pressure when clip-on chuck is attached to tire valve stem and inflation pedal is released.
- C Release Valve** — Allows the manual release of air pressure from tire when clip-on chuck is attached to tire valve.
- D Left Helpers and Support** — Includes mount/demount helpers, slide, cylinder, and valve for operation.

- E Inflation Pedal** — Three-position pedal that allows inflation of tires through air hose and clip-on chuck.
- F Bead Lifting Tool** — Used to lift and position tire bead correctly on duckhead®.
- G Clamps** — Holds wheel to tabletop for tire changing. Position outward to allow outside clamping of wheels.
- H Right Helpers and Support** — Includes mount/demount roller and disk, slides, cylinder and valve for operation.

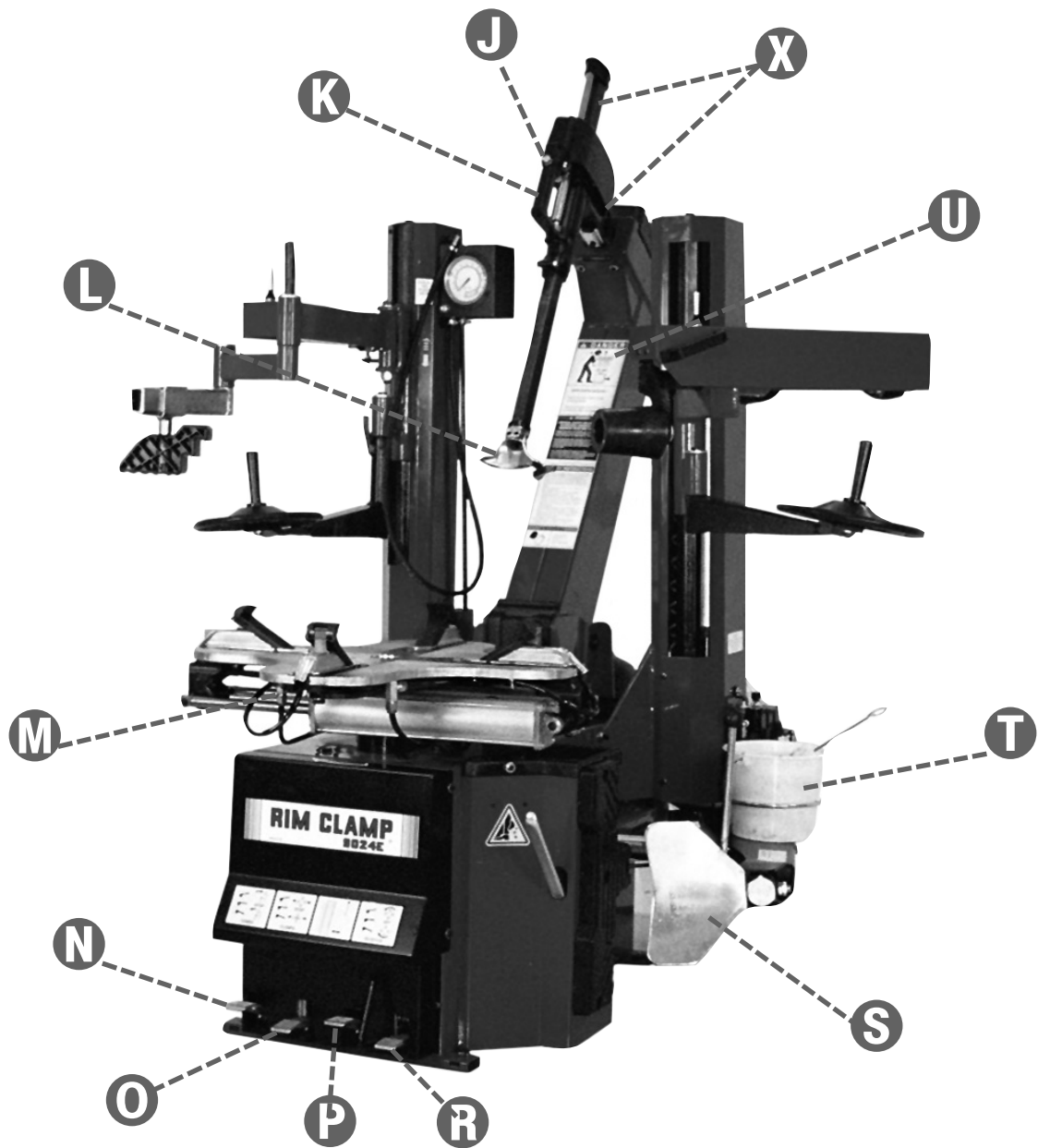

- J Slide Locking Valve** — Locks and unlocks horizontal/vertical slide and sets correct vertical/horizontal position to maintain duckhead/wheel clearance.
- K Slide Adjustment Handle** — Adjusts horizontal/vertical slide assembly for proper horizontal and vertical positioning of duckhead®.
- L DuckHead®** — Mounts and demounts tire from wheel.
- M Bead Sealing Nozzles** — Expands tire sidewall to bead seat area of rim to seal tire to rim and allow inflation.
- N Tower Tilt Pedal** — Two-position pedal that moves tower forward or back.
- O Clamp Control Pedal** — Three-position pedal that opens, holds, or closes rim clamps.
- P Bead Loosener Pedal** — Controls operation of bead loosener shoe.
- R Tabletop Pedal** — Three-position pedal that controls rotation of tabletop (forward, off, reverse).
- S Bead Loosener Shoe** — Pivoting shoe for loosening tire beads.
- T Lube Bucket** — Dispenser for rubber lubricant.
- U Important Safety Decal** — Important safety information for the operator. DO NOT obstruct with tire stickers or other materials.
- X Horizontal and Vertical Slides** — Allows correct positioning of duckhead®.

Operating Instructions

This unit must be properly operated and properly maintained to help avoid accidents that could damage the unit and injure the operator or bystanders. This section of the Operating Instructions manual reviews basic operations and use of controls. These instructions should be reviewed with all employees before they are allowed to work with the machine. Keep these instructions near the machine for easy reference.

Bead Loosening and Demounting



This machine may operate differently from machines you have previously operated. Practice with a regular steel wheel and tire combination to familiarize yourself with the machine's operation and function.

A. Remember to remove all weights from both sides of the wheel. Weights left on backside of wheel may cause the wheel to be clamped unlevelled. This may result in the combination duckhead® contacting the rim causing scratches. On alloy wheels, always rotate the wheel one turn after setting the duckhead to insure proper wheel chucking.

B. Always review with the owner any nicks and scratches on expensive wheel and tire combinations prior to servicing.

C. Review the performance wheel section of this manual prior to servicing performance tire/wheel combinations.



Loosening the beads on a partially or fully inflated tire is unsafe and causes excess movement and friction against the bumper pads and excessive wear on pivots. Deflate the tire completely to prolong the life of your machine.

1. Deflate the tire completely by removing the valve core from the valve stem (figure 1). Be cautious and do not smoke as a *flammable gas could have been introduced into the tire at some time.*



Figure 1 - Remove Valve Core to Deflate Tire



Tires are always installed and removed from the rim's narrow side.

D. Always loosen the bead on the narrow side of the wheel's drop center first. See figure 2 for more information on the drop center.

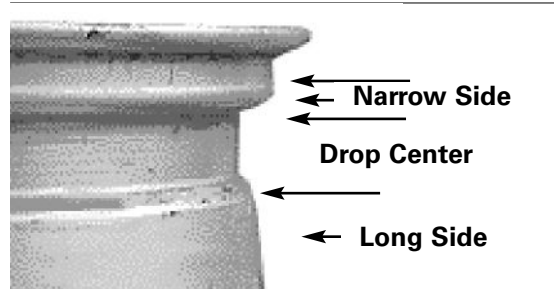

Figure 2 - Determine Narrow Side of Wheel

E. The clamps on the tabletop may extend beyond the tabletop itself. To avoid damaging the clamps, move them to their full inward position before positioning a tire for bead loosening.

F. Use extra care in positioning the bead loosener shoe on larger wheels/tires, and on alloy wheels. Make sure the shoe rests next to but not on the rim, and not on the tire sidewall.

2. Pull the bead loosener shoe away from the machine and roll wheel into position. The valve stem should be in the 2 o'clock position to accommodate a possible asymmetric safety hump type rim. Position the bead loosener shoe against the tire next to, but not on, the rim. Press the loosener pedal to actuate the shoe and loosen the bead. It may be necessary to loosen the bead in multiple locations around the tire (figure 3).



Figure 3 - Position Tire and Bead Loosener Shoe

3. Turn the wheel around and repeat loosening procedure on the other side of the wheel (figure 4). Note that the valve is placed at 2 o'clock for the initial loosening procedure to accommodate a possible asymmetric safety hump type rim.



Figure 4 - Position Tire and Bead Loosener Shoe with Wheel Turned Around

G. It will be easier to outside clamp the wheel to the tabletop if the long side of the rim is loosened last.

4. Determine the mounting side of the wheel. The mounting side is the narrow side of the drop center (tire removed in figure 2 for clarity).



Avoid back injury, seek assistance when lifting heavy tire/rim assemblies onto the tire changer.

5. Place tire/wheel assembly on tabletop with mounting side up (figure 5 & 6). Use the clamp control pedal to move the clamps inward (push pedal down). Use the clamp control pedal to move the clamps outward (toggle pedal up).



Figure 5 - Clamp Outside on Mag Wheels

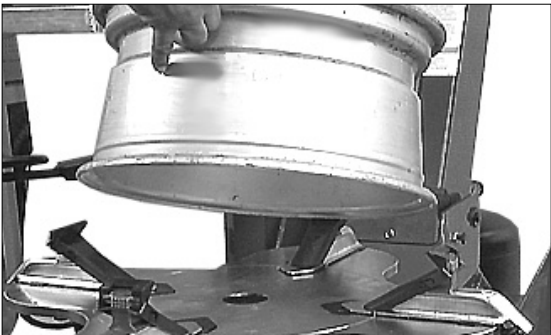

Figure 6 - Outside Clamped with Tire Removed

6. Take time to experiment with the duckhead® locking system (figure 7).

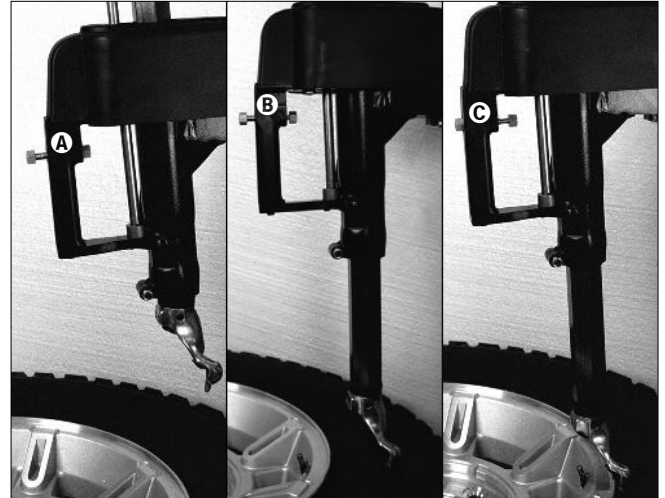

Figure 7 - With Valve Button as Shown, **A** Duckhead Retracts Up, **B** Duckhead Descends Slowly, and **C** Duckhead Locks into Position



Make sure the duckhead is in the retracted position before moving the tower forward, to prevent wheel damage.

7. Using the foot pedal, position the tower forward (figure 8). See figure 7 for duckhead movement and locking. With the tower forward, allow tool to descend on the tire sidewall (figure 8). Then move the tool toward the rim and actuate the locking button. As the tool locks into place, the duckhead will move up and back about 1/8-inch.

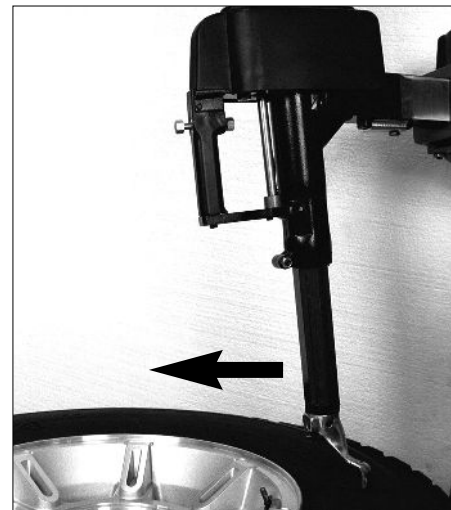

Figure 8 - Position Duckhead

8. The duckhead should not be in contact with the rim edge after the duckhead is locked.

9. Check duckhead® positioning. Duckhead should be positioned with 1/8 to 3/16-inch clearance between the top of the rim edge and the bottom of the duckhead, and 1/8 to 3/16-inch clearance between the top of the rim edge and the duckhead roller. This clearance will be maintained as long as the slide locking valve remains locked. The operator may move the tower back out of the way and back into place again without needing to reposition the duckhead (when clamping a like set of wheels).

H. The tool clearance may change with machine use and should be inspected often. Failure to maintain the proper clearance may result in damage to the wheel rim and/or tire.

K. Normal tabletop rotation for demounting is clockwise. Depress the tabletop pedal to rotate this direction. To rotate the tabletop counterclockwise, lift the pedal up with your toe.

L. Tabletop rotation can be stopped at any time by removing your foot from the rotation pedal.



At times during the mounting and demounting procedure, the bead lifting tool may encounter resistance and can be thrown. Keep one hand firmly on the tool to avoid possible tool disconnect. Use the reversing feature to back out of jam-ups. A thrown tool can cause injury.

10. Apply tire manufacturer's approved rubber lubricant liberally to entire circumference of both beads after loosening and placing on tabletop. Using R.H. helper to hold down top bead while rotating wheel will make lubrication easier (figure 9).

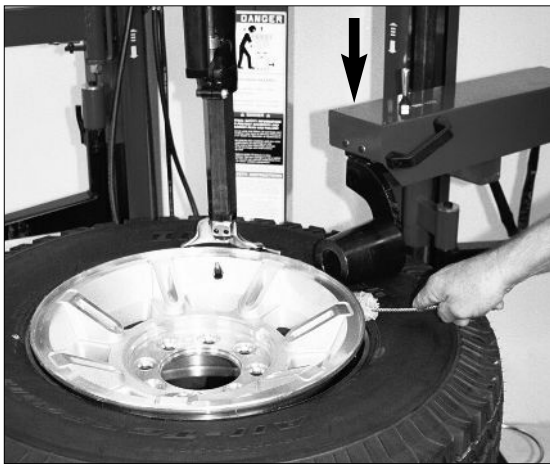

Figure 9 - Apply Rubber Lubricant to the Beads

11. Insert smooth curved end of the bead lifting tool over the clockwise end of duckhead and below the upper bead of the tire. Lift the bead up and over the knob on the duckhead (figure 10). Also, note the valve stem position to the duckhead, this position reduces stresses in the bead and allows an easier bead lift. Push down on the tire opposite the duckhead to allow the bead utilize the drop center area of the rim.

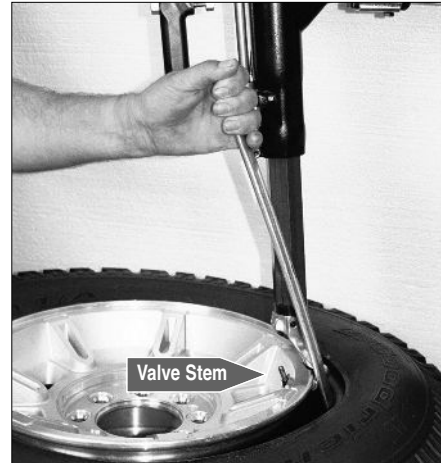

Figure 10 - Insert Bead Lifting Tool

12. Depress the tabletop pedal to rotate the wheel. The duckhead will guide the tire bead up and over the edge of the wheel (figure 11). Continue rotation until the upper bead is demounted.



Figure 11 - Demount Upper Bead

13. For lower bead removal lift the tire (figure 12) and insert the lift tool same as on upper bead (figure 13). On large or heavy tires, the helper arms may be used to lift the tire.



Figure 12 - Lift the Tire for Lower Bead Removal

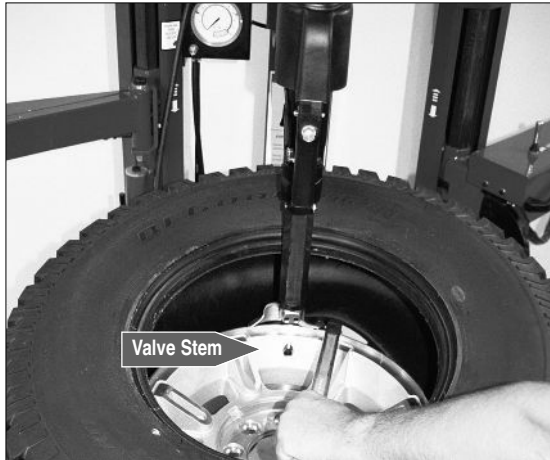

Figure 13 - Insert Bead Lifting Tool

14. With the tire in position (note that the valve stem is under the duckhead), rotate the lever down to position the bead on top of the duckhead. Depress the foot pedal to rotate the tire. The duckhead will guide the lower tire bead off of the rim.

M. With tube-type tires, demount the upper bead and remove the tube before demounting the lower bead.

After successfully completing the demount process, proceed to MOUNTING.

Mounting

This information must be read and followed carefully to prevent accidents and injuries during mounting.



Attempts to force a bead seat on mismatched tires and wheels can cause the tire to violently explode, causing serious personal injury or death to operator and/or bystanders.



Check tire and wheel carefully before mounting. Make sure the tire bead diameter and wheel diameter match exactly. Consult the Tire Guide and/or Rubber Manufacturer's Association for approved rim widths for tire sizes.



Never mount a damaged tire. Never mount a tire on a rusty or damaged wheel. Damaged tires and/or wheels may explode.



When in doubt do not mount.



Never mount a tire and wheel handed to you by anyone without checking both tire and wheel for damage and to be certain the sizes match. Do not let untrained persons operate tire changer and keep bystanders out of service area.



Forcing the tire onto the rim can cause bead damage. If you damage the tire bead during mounting, STOP!, remove the tire and mark it as damaged. Do not mount a damaged tire.

1. Before any mounting, inspect the tire for damage and verify size match between tire and wheel (fig. 14).



Figure 14 - Verify Size Match Between Tire and Wheel

2. Inspect the wheel closely for damage. Clean the wheel and remove any light corrosion or rubber residue (figure 15). Do not attempt to service a heavily corroded wheel, damaged wheel, or bent wheel.



Figure 15 - Inspect and Clean the Wheel

3. Inspect the valve stem and replace if necessary. Next lubricate the tire beads liberally with tire manufacturer's approved rubber lubricant (figure 16).



Figure 16 - Lubricate Tire Beads Liberally

4. Place tire over wheel and move tower arm into position. Position tire so that the lower bead is above the rear extension of the duckhead® and below the front knob (figure 17).



Figure 17 - Position Tire Against Duckhead

5. Depress tabletop pedal and rotate the wheel to mount the lower bead. Use the drop center of the wheel by forcing down on the tire just ahead of the mounting tool and follow as the tire rotates (figure 18). Rotate the tabletop until the lower bead is mounted.

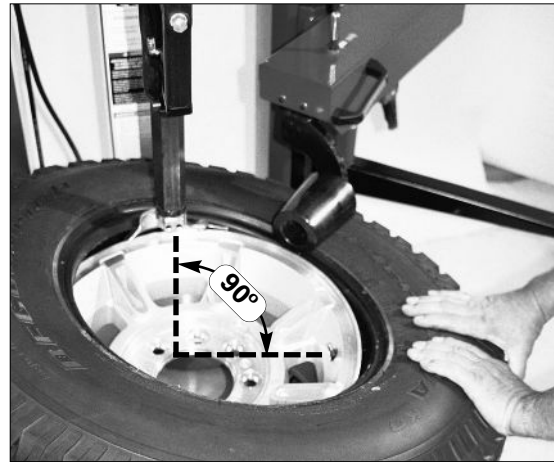

Figure 18 - Mounting Lower Bead

6. For top bead installation, rotate the tabletop until the valve stem on the wheel is 90 degrees ahead of the duckhead (at the 3 o'clock position). Lift the upper bead of the tire up and over the rear of the duckhead. With your hand or using the power roller, press down on the tire sidewall between the duckhead and the valve stem to hold the tire in the rim drop center. The bead should also be under the right side of the knob on the duckhead (figure 19). Depress the tabletop pedal and rotate the tire until the bead is mounted. Be careful to assure the bead stays in the rim drop center in the area ahead of the duckhead.



Figure 19 - Mounting Top Bead

P. If tabletop rotation stalls, reverse the tabletop momentarily until the tire bead is again loose on the wheel. Reposition the tire on the duckhead, make sure the bead is correctly positioned in the drop center of the wheel; then attempt mounting again.

R. For tube type tires, mount the lower bead first, move the tower back, install the tube, and then mount the upper bead.

Inflation

Tire inflation is performed in three steps: BEAD SEAL, BEAD SEAT, and INFLATION. These steps are explained in detail on page 12. Read the explanation of each step and understand them thoroughly before proceeding.



Tire failure under pressure is hazardous. This tire changer Will Not Restrain Exploding Tires, rims or other related equipment. Inspect tire and wheel carefully for match, wear, damage, or defects before mounting. Always use approved tire bead lubricant during mounting and inflation.



The clip-on chuck allows the operator to keep hands and entire body back from inflating tire. The chuck must be an open/freeflow style with all parts in proper working order.



Check for proper inflation gauge operation. Accurate pressure readings are important to safe tire inflation. Refer to the Operating Maintenance section of this manual for instructions.

The inflation pedal, located at the center of the left side of the machine, controls the flow of air through the inflation hose, and has three positions.

Note: The clip-on chuck on the end of the hose should always be an open/freeflow style with all parts in proper working order.

Position 1 - Tire Pressure – With the inflation hose attached to the tire valve and the pedal in this position, the air gauge will register the air pressure in the tire. Whenever your foot is removed from the pedal, it will return to this position.

Position 2 - Tire Inflation – This is the first activated position. With the inflation hose attached to the tire valve and the pedal in this position, line pressure is allowed to flow through the valve system and into the tire for inflation. Correct tire pressure is not indicated on the gauge in this position.

Position 3 - Bead Sealing – This is the second and last activated position. With the inflation hose attached to the tire valve and the pedal in this position, line pres-

sure is allowed to flow through the valve and to the air-plate bead seal jets on the tabletop for bead sealing.

1. If the rim has been clamped from the outside for tire mounting, release the clamps, lift the tire, and move the clamps to the center of the tabletop.

The inflation pedal, located at the center of the left side of the machine, controls the flow of air through the inflation hose.

Note the Pedal Positions (See Diagram)

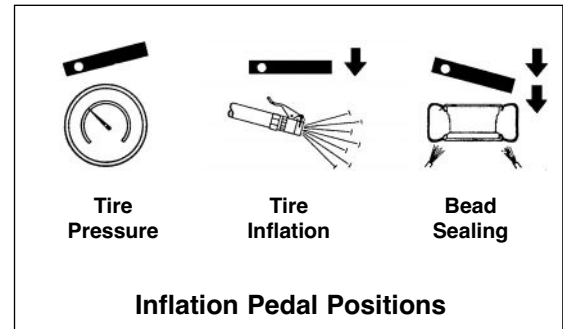

Use of bead sealing jets without a tire in place can cause dirt and debris to be blown into the air with enough force to injure operator and/or bystander. Do not use the bead sealing control position to inflate a tire.

R. This unit is equipped with a pressure limiter to assist the operator with proper tire inflation. When the inflation pedal is held in position 2, the pressure limiter cycles the machine between position 2 (inflation) and position 1 (at rest, no airflow to tire). This cycling helps to prevent over inflation of the tire. Tires can still be over inflated and explode with the use of this pressure limiter if all of the instructions in this manual are not followed completely. The pressure limiter will keep most car and light truck tires from inflating beyond 60 PSI (smaller tires may reach higher pressures). It is the operator's responsibility to follow all instructions and to control inflation pressure as specified in these instructions. Check the function of the pressure limiter regularly and maintain it according to the instructions provided in this manual for safe and proper operation. Do not tamper with or attempt to adjust the pressure limiter. Tires requiring inflation beyond 60 PSI should be inflated in a safety cage.

Bead Sealing

1. Position valve stem in front of operator and connect the inflation hose with the clip-on chuck. Hold tire up against upper edge of the wheel. Be sure tire's top bead does not cover the bottom of the valve stem (figure 20).



Figure 20 - Lift Tire Upwards for Bead Sealing

2. Depress inflation pedal to position 2 and hold about one second to begin air flow through tire valve, then depress pedal to position 3 and hold briefly — less than one full second. The blast of air from the jets will expand tire and seal the beads.

3. Release the inflation pedal and allow it to return to position 1. Verify that both beads are completely sealed to the wheel. Repeat these steps if beads have not sealed. It may be necessary to wait a few seconds for the air storage tank pressure to recover before attempting again.

S. If tire and wheel are properly lubricated and operator cannot achieve bead seal after three or four attempts, the valve core may be removed from the valve stem to allow more air flow into the tire to assist with bead seal. After bead seal is achieved, remove the clip-on chuck and reinstall the valve core. Reattach the clip-on chuck after core is installed.

Bead Seating



NEVER exceed 40 PSI to seat beads while using this tire changer. If more than 40 PSI is permitted by tire manufacturer, ALWAYS use safety cage and clip-on chuck. NEVER exceed recommended pressure after seating beads. ALWAYS keep hands and entire body back from inflating tire.

An exploding tire, wheel, or bead sealing equipment may propel upward and outward with sufficient force to cause serious injury or death to operator or bystander.



Check tire pressure frequently. If operator is unable to obtain Bead Seat, something is wrong. Deflate tire completely, inspect tire and wheel, correct any problems found, relubricate both tire beads, and reattempt Bead Seal and Seat procedures. Follow all safety instructions in this manual and on machine.

1. Once tire pressure is indicated on the air gauge (inflation pedal in position 1; foot removed from pedal), continue to inject air into the tire (inflation pedal position 2) in short intervals. Check the pressure frequently. Stand back during bead seat. Keep hands, arms, and entire body away from tire during this procedure (figure 21).



Figure 21 - Stand Back during Bead Seat

Inflation



NEVER exceed tire manufacturer's recommended air pressure. Tires can explode, especially if inflated beyond these limits. Use clip-on air chuck, keep hands, arms and entire body back from inflating tire. Avoid distraction during inflation. Check tire pressure frequently to avoid over inflation. Excessive pressure can cause tires to explode, causing serious injury or death to operator or bystander.

1. Make sure both beads are seated. When both beads are seated, the tire is ready for inflation.
2. Replace the valve core if it was removed.
3. Depress the inflation pedal to position 2 to inflate the tire. The pressure limiter will cycle the air flow as described earlier. On most tires, the pressure limiter will cease air flow at approximately 60 PSI. On smaller volume tires the pressure may be higher.
4. Release air pressure from tire by pressing the manual release valve button (inflation hose must be attached to the valve stem, Figure 22). Never add or adjust tire pressure using an air hose without a clip-on air chuck and in-line valve. Do not use a hand-held style chuck (figure 23).
5. **Important:** When inflating tires that require more than 60 PSI, always use a safety cage and air hose with a clip-on air chuck and in-line valve. The air hose must have enough length between the chuck and the operation/in-line valve to allow the operator to stand outside the trajectory.



Figure 22 - Location of Manual Release Valve



Figure 23 - Do Not Use a Hand-held Style Air Chuck

<p>! DANGER</p> <p>Explosion Hazard Never exceed 40 PSI while seating beads.</p> <p>Remember R.I.M. (see page iv and back cover)</p>		<p>! DANGER</p> <p>Explosion Hazard Never inflate tire above manufacturer's recommended pressure after bead is seated.</p>
--	--	---

Stages of Inflation on a Conventional Tire and Rim

Review these descriptions and diagrams carefully. Refer to them as necessary during bead sealing, bead seating, and inflation to verify that you are proceeding properly and safely.

Bead Sealing

Bead sealing is the process of capturing air pressure between the tire and the rim. The tire will usually contain about 1/2 to 2 PSI at initial bead seal

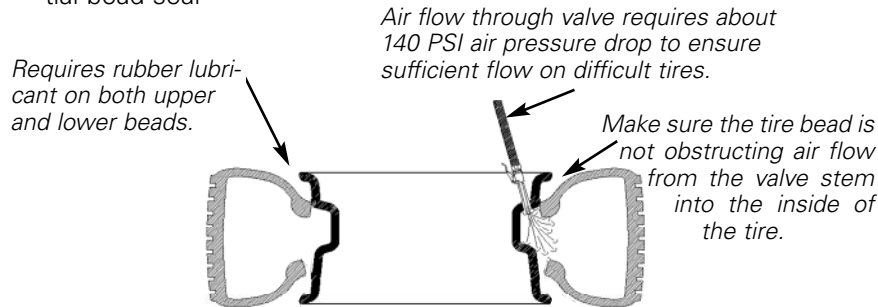

Bead Seating

Bead seating usually occurs on the long tapered side of the wheel first and the shorter side last. Bead seating will usually require at least 7 PSI in the tire. 40 PSI is the maximum safe pressure at this stage regardless of tire operating pressure.

Most European import cars and many aftermarket alloy wheels are very tight and can be difficult to bead seat. Also note that asymmetrical hump and run-flat tires are extremely difficult to bead seat. Follow tire manufacturer's recommended procedure for bead seating.

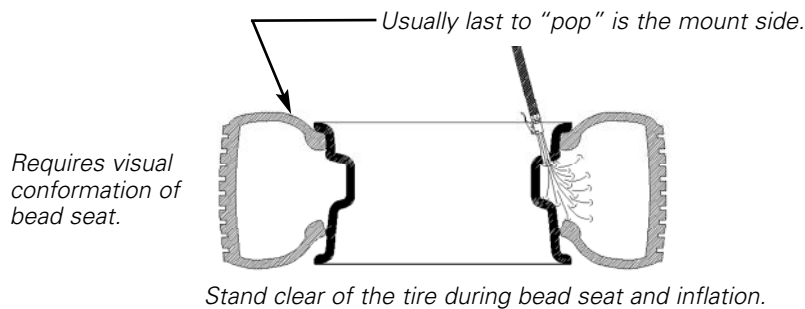

Inflation

After the beads are seated, the tire is ready to be inflated. Do not inflate the tire above the manufacturer's recommended pressure as stamped on the tire sidewall. The typical inflation pressure for automobile tires is between 24 and 45 PSI. Light truck inflation pressure typically covers a wider range.

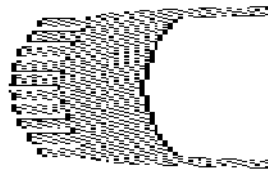

Stand clear of the tire during inflation.

Mismatched Tires and Wheels

Never attempt to mount and inflate mis-matched tires and wheels.



Mismatched tire and wheel combinations can explode, causing personal injury or death to operator and/or bystanders.

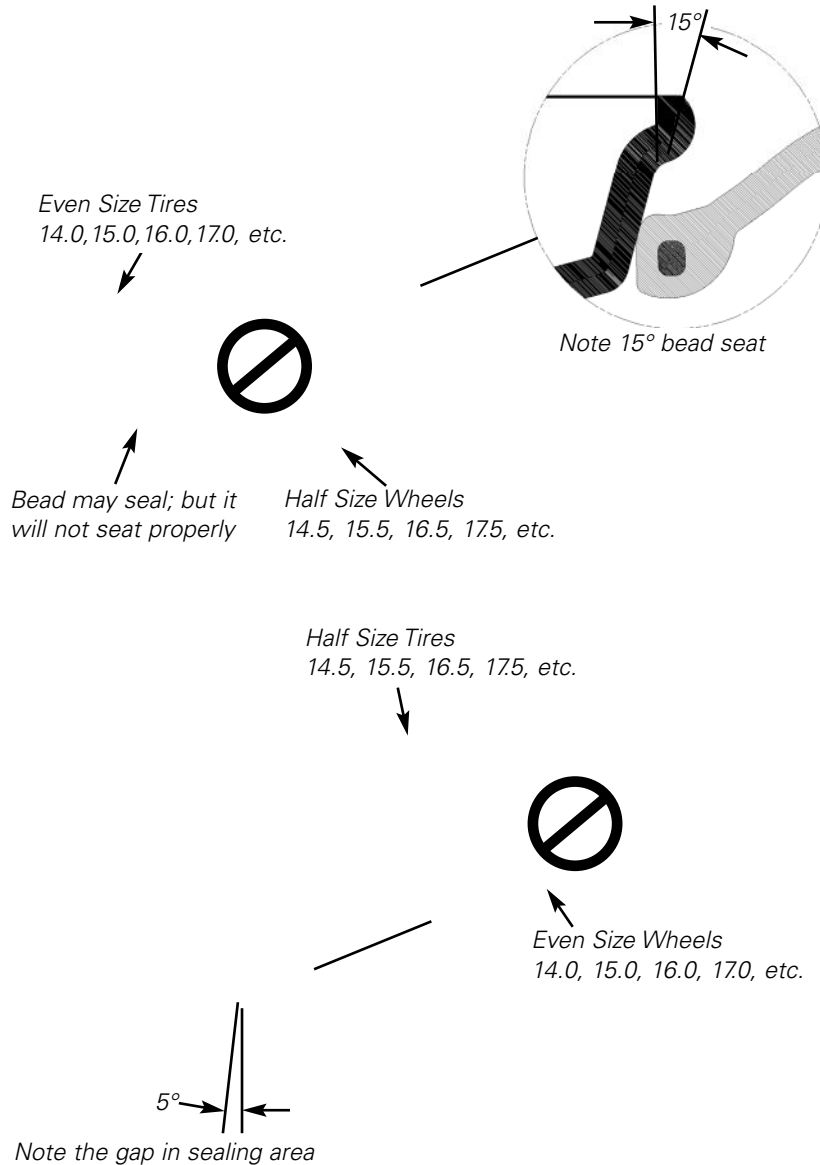

Performance, Custom, and Aluminum Wheels



To avoid personal injury or damage to components only tire technicians with experience and training on custom wheels should attempt to service expensive custom alloy or aluminum wheels, high-performance low-profile tires and EMT/run-flat tires.



Many tires/wheels have pressure sensor devices that are manufactured by different companies, there are no standards on type or mounting; therefore, follow the instructions that apply to the sensor being serviced. For further information on these devices, contact the individual sensor manufacturer.

Pre-Operation Notes:

- Ensure all weights have been removed.
- Assistance will be required on wide wheels.
- Clamp wheel from the outside.
- Use ample lubricant for mounting and demounting
- Always review wheel nicks and/or scratches with the owner before servicing.

Performance Tires & Wheels • Demounting

Follow these instructions for performance type tires and wheels, including run-flat tires and their associated wheels, and asymmetrical hump wheels.

1. Remove the valve core and completely deflate the tire. On many performance wheels a valve type sensor may be inside of the rim. These devices are expensive and should be serviced with care. After deflating the tire, loosen and remove the retaining nut and then tap lightly with a hammer to allow the valve sensor to fall inside the tire before further service work (figure 24).



Figure 24 - Rim with a Valve Type Sensor (Tire Removed for Clarity)

2. Some wheels have a low-pressure sensor/transmitter strapped to the wheel. This is especially true on run-flat tire/wheel systems. To avoid damaging the sensor, always loosen the top bead with the valve stem at the 2 o'clock position first, to determine sensor location. Then loosen the bottom bead and the remaining circumference of the beads as necessary at a location that will not damage the sensor. (Figure 25).

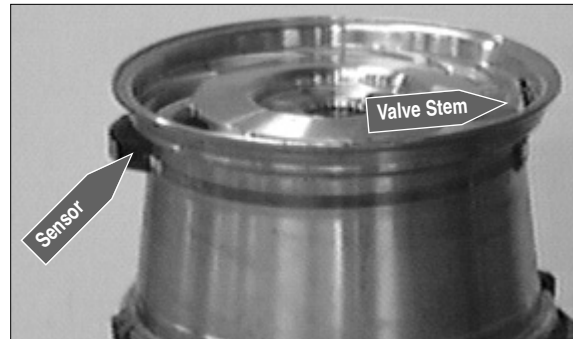

Figure 25 - Wheel with Strapped on Low Pressure Sensor/Transmitter

3. Wheels with an asymmetrical hump have a larger "ledge" type hump around the wheel except at the valve hole making them more difficult to mount and demount loosen bead (Figure 26).

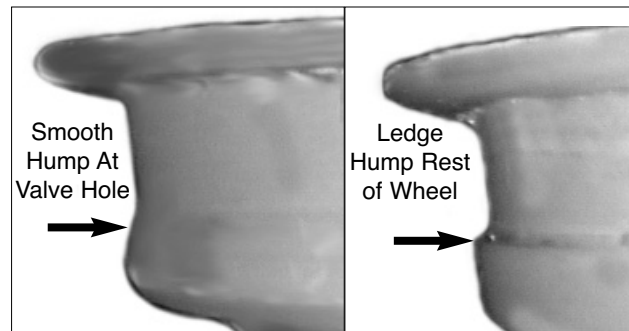

Figure 26 - Asymmetrical Hump Wheel

4. Pull the bead loosener shoe away from the machine and roll the tire in position with the valve stem in the 2 o'clock position (above the bead loosener shoe). Always loosen the bead on the narrow/mounting side of the wheel first (figures 2 and 27).

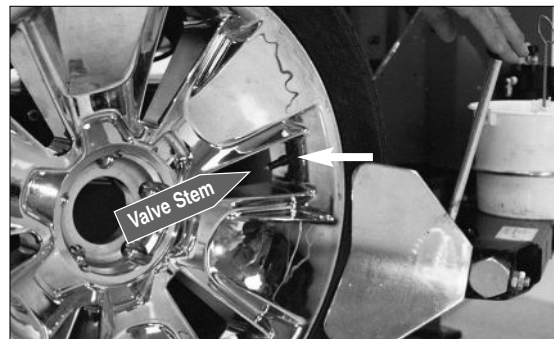

Figure 27 - Position Tire for Bead Loosening

5. Loosen bottom bead, starting with valve stem positioned at the 2 o'clock position above the bead loosener shoe (figure 28).



Figure 28 - Loosen Bottom Bead

6. Liberally lubricate the bottom bead of the tire (figure 29).



Figure 29 - Lubricate Bottom Bead

7. After loosening and lubricating the lower bead, rotate the tabletop until the clamps are in the 12, 3, 6, and 9 o'clock positions (Figure 30).

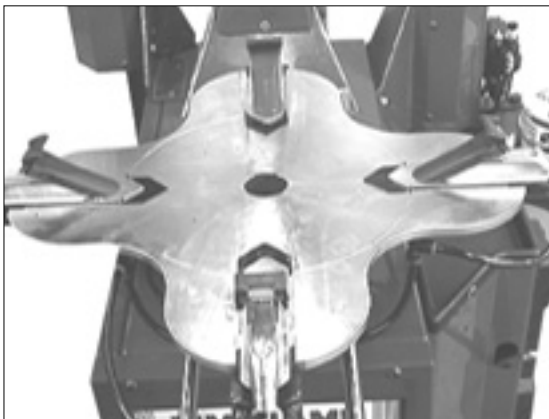

Figure 30 - Rotate Tabletop to 12 O'clock



Avoid back injury, seek assistance when lifting heavy tire/rim assemblies onto the tire changer.

8. Clamp wheel from the outside. Position rim edge into clamp at 12 o'clock position. Lower the wheel and depress the clamp control pedal. Slowly move the clamps inward until they securely contact the outside edge of the rim (Figure 31).

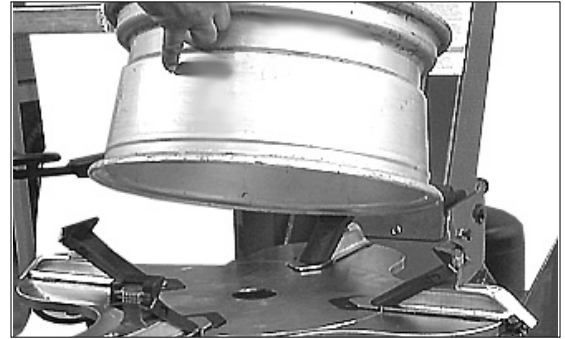

Figure 31A - Clamp Wheel (Tire Removed for Clarity)



Figure 31B - Outside Clamped with Tire Removed

Tip: This is usually accomplished by crouching down in front of the tire changer, holding the wheel with the right hand, and operating the clamp control pedal with the left hand. This allows the operator to watch the clamps as they move inward to ensure proper, damage-free clamping.

9. After clamping the tire and wheel, position the duckhead® as explained in the previous section.

10. Lubricate upper bead liberally. Use the R.H. tapered roller to help push the tire bead down so bead area is easier to reach for lubrication (figure 32).



Figure 32 - Lubricate Upper Bead

11. After bead lubrication, position the tire and wheel for demounting by locating the valve hole or stem in front of the duckhead® (figure 33).

12. Next, position the L.H. helper opposite the duckhead and apply a force to the tire that will allow the bead to slide into the drop center of the rim as the bead is lifted onto the duckhead (figure 33).

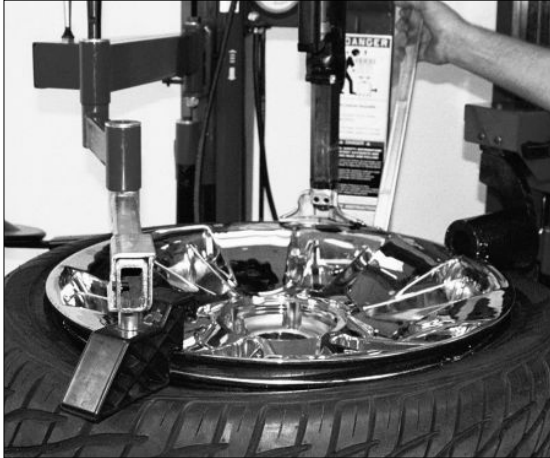

Figure 33 - Position Tire/Wheel for Demounting

13. Next, insert the lift tool into the tire, rim intersection, raise the (R.H. helper) taper roller from the tire sidewall and lift the bead carefully onto the right side of the duckhead (figure 34).



Figure 34 - Lift Bead Carefully onto Duckhead

14. Next, raise the (R.H. helper) from the tire sidewall and move to the stored position. Next, jog the machine rotation to start the upper bead removal (figure 35), continue rotation until the upper bead is completely removed from the rim.



Figure 35 - Start Upper Bead Removal

15. Once the upper bead is removed, review the wheel for strap-on type sensors. Position the plastic disks under the lower sidewalls and raise the lower sidewall of the tire to the top of the drop center of the rim (figure 36).



Figure 36 - Raise Lower Bead to Top of Drop Center of the Wheel

16. With the tire in the up position, insert the lift bar and raise the lower bead onto the duckhead (figure 37).

17. Lower the lift disk on each side and move them away from the tire (figure 37).

18. Depress the rotation pedal and dismount the lower tire bead from the rim (figure 37).



Figure 37 - Dismount the Lower Tire Bead from the Rim

Performance Tires & Wheels • Mounting

Before beginning any of the mounting activities, review all of the caution, warning and danger instructions associated with mounting already listed in the early part of the manual concerning tire/rim size match, inspect for damage, etc.

19. Install or review condition of any pressure sensor devices. This will prevent having to remount the tire later.

20. Begin the tire mounting process by lubricating both tire beads and the rim if necessary (figure 38).



Figure 38 - Lubricate Tire Beads

21. For mounting the lower bead; position the tire at an angle to the rim and mount (figure 39).



Figure 39 - Mount the Lower Bead

22. Next position the rim for the best mounting by assuring the valve stem or sensor devices will not prevent the upper bead from using the wheel's full drop center. Typically valves or sensor devices are positioned at 90 degrees forward of the duckhead.

23. Next position the R.H. taper roller on the tire and press the sidewall down even with the wheel's drop center. Next position the L.H. drop center tool at the 3 o'clock position and force down on the tire sidewall allowing the step on the plastic duckhead to engage the rim (figure 40)



Figure 40 - Position R.H. and L.H. Helpers

24. Start the mounting process by jogging the rotation of the machine (figure 41). On very low profile tires, it may be necessary to utilize the lift tool to assist in maintaining the tire bead in the wheel's drop center (figure 42).



Figure 41 - Jog Machine Rotation



Figure 42 - Utilize the Lift Tool if Necessary

25. The L.H. helper should follow the bead lock as the tire is mounted; however, after the bead lock is in the 10 o'clock position the L.H. helper should be removed from the tire and rim (figure 43).



Figure 43 - The L.H. Helper Should Follow the Bead Lock

26. Same as 43.

Note: Mounting the top bead can be very difficult when mounting new tires on performance and custom wheels. Proceed slowly and cautiously.

Custom and Special Wheels



Should a problem be encountered during assembly or disassembly **STOP!** Avoid damaging the other wheels. Continue assembly only when problem is identified and corrected.

Alloy Wheels: Some manufacturers offer wheels with little or no drop center. These are not DOT approved. The tire or wheel (or both) can be damaged and the tire could explode under pressure, resulting in serious injury or death. If you attempt to mount/demount this type of wheel, use extreme caution (Figure 37).

European Performance Wheels (Asymmetrical Hump): Some European wheels have very large humps except near the valve hole. On these wheels, the beads should be loosened near the valve hole on both the upper and lower sides first (Figure 26 & 44).

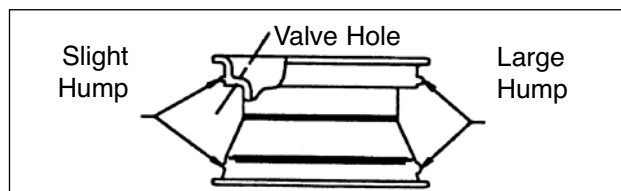

Figure 44 - Asymmetrical Safety Hump Wheels

Maintenance Instructions

Read and follow all the maintenance instructions provided in this manual to keep the machine in good operating condition. Refer to the other materials received with the unit and to the service bulletins from the manufacturer for additional instructions on proper maintenance and service. Regular inspections and proper maintenance are essential to preventing accidents and injuries.



Before making any inspection, adjustment, or repair, disconnect the power source and block out all moving parts to prevent injury.



Keep the machine and the immediate work area clean. Do not use compressed air to remove dirt and debris from the machine. Foreign material may be propelled into the air and into operator or bystander causing personal injury.



Wear protective clothing, equipment and eye protection when making any adjustments or repairs to the machine.

A. The vertical and horizontal slides and the helper slides should be cleaned with a vaporizing solvent and then lubricated with chassis grease once a month.

B. Check the adjustment of the duckhead once a month.

C. The transmission in this machine is a sealed unit packed with grease and should need no normal maintenance.

D. The tabletop, clamps, steel duckhead, and other working surfaces should be cleaned with a vaporizing solvent every month.

E. The clamps should be inspected and metal chips and dirt removed from the serrations with a wire brush once a month.

F. Check the tire pressure gauge function daily, and check the accuracy monthly. Use a pressurized tire and a high quality stick-type pressure gauge. If necessary, adjust the dial of the machine gauge. If the gauge is defective, replace it immediately (part number 107985). Contact COATS at (615) 641-7533. Check

function of the pressure limiter weekly. Always reinstall the lens after adjusting the gauge.

G. Make sure all fasteners are securely tightened.

H. Make certain that all guards and covers are in place.

I. Check for worn, damaged or missing parts including grips and protective covers. Replace them before allowing the unit to be used.

J. On a daily basis, inspect the unit and check to be certain that all systems are operating normally. Detailed inspection and testing procedures are specified for various components at regular intervals. Set up a chart and assign responsibility for these items.



Replace any damaged or missing safety decals. They are available from COATS, (800) 688-6359.

Important: These instructions will help you service the unit. Instructions are for a person with some mechanical ability and training. No attempt has been made to describe all basic steps. For example, how to loosen or tighten fasteners. Also basic procedures such as cycling systems and checking operation of the equipment are not fully described since they are known to anyone who does mechanical and service work. Do not attempt to perform work beyond your ability or at which you have no experience. If you need assistance, call an authorized service center or contact COATS directly, (800) 688-6359.

Separator/Lubricator Maintenance

Check oil and water levels regularly, and perform these maintenance items weekly:

- A.** Disconnect air supply to machine.
- B.** The Separator (Filter) unit is equipped with an automatic drain and should not normally need draining.
- C.** If the fluid level is greater than 1/4" from the top of the gauge, add oil. Remove the filler plug on top of the lubricator and add SAE 10W non-detergent oil or an air tool oil to bring the level up to 1/4" from the top of the gauge. Replace filler plug and clean up any spilled oil.
- D.** Adjust the oil flow by turning the black flow adjustment knob and turning it to increase or decrease the flow. Watch the formation of oil drops in the see-through oil chamber. Reconnect the air supply and continually cycle the bead loosener through full strokes and count the drips during the cycles. The delivery of oil to the airline should be about 1 drop per 10 cylinder cycles. Adjust flow as required.

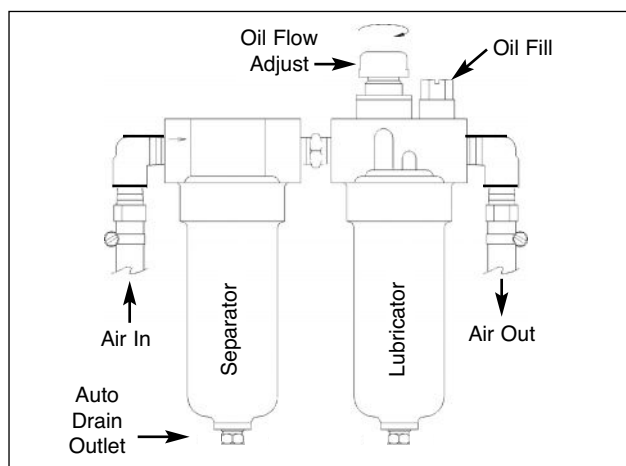

Duckhead® Cleaning

Clean dirt and debris from the duckhead roller with a small screwdriver or pick.

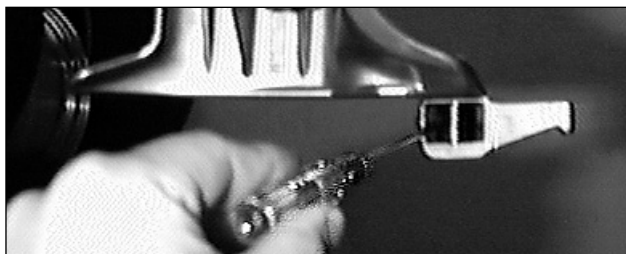

Pressure Limiter Maintenance



Operating a tire changer with a defective, improperly adjusted, or by-passed pressure limiter could cause an operator to accidentally over pressurize a tire, resulting in a tire explosion with severe injury or death to the operator or bystanders.

Always be sure that the pressure limiter is present and is operating properly.



Never inflate tire above manufacturer's recommended pressure after bead is seated. Pressure limiter is set at 60 PSI. Any required inflation above 60 PSI should be performed in an inflation chamber/safety cage or securely mounted on the vehicle if an inflation chamber is not available. A tire explosion may cause personal injury or death to operator or bystanders.

The pressure limiter helps prevent inflation of standard size or larger tires or tubes beyond 60 PSI to minimize risk of explosion. This device is for the safety of the operator and bystanders. Proper operation of the pressure limiter is essential to safe operation of the machine.

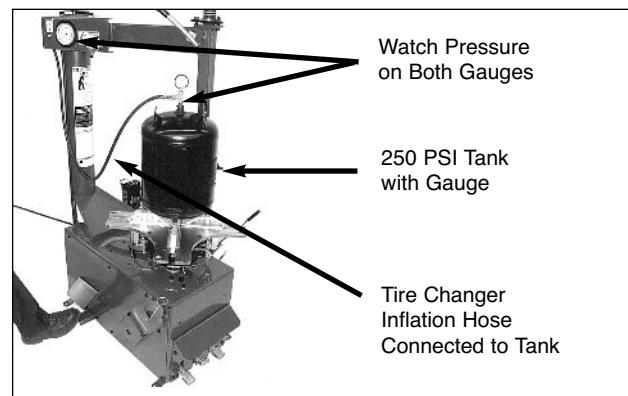

Check operation of the pressure limiter as shown and described below at least monthly:

- 1.** Remove tires and/or wheels from the machine.
- 2.** Connect the inflation hose to an empty service tank with a pressure gauge (gauge should read 0). Use a certified tank with at least 250 PSI pressure rating.

3. Depress inflation pedal to position 1 to start air-flow through the hose and into the tank. Maintain a steady pressure for constant flow.

4. Watch the rising pressure on the tank gauge and the gauge on the machine. Machine gauge should cycle between check and inflation pressures while tank gauge climbs steadily. As tank pressure reaches 60 PSI, the pressure limiter should stop the airflow automatically. Both gauges should read 60 PSI \pm 5 PSI.

5. Release inflation pedal. Check manual release valve function by pressing the button and releasing pressure from the tank until it reaches 50 PSI. Disconnect inflation hose, and release air inside tank.

6. Replace pressure limiter if it fails to cycle properly during inflation, if it fails to shut air supply off at 60 PSI, or if it malfunctions in any other way. Do not operate machine with a faulty pressure limiter.

Installation Instructions



Proper unit installation is necessary for safe use and efficient operation. Proper installation also helps protect the unit from damage and makes service easier. Always place safety poster and instructions near the unit.

Location

Select a location using the drawings below. The area should provide the operator with enough space to use the equipment in a safe manner. The area selected should be well lit, easy to clean and should be away from oil, grease, brake lathe chips, etc. Avoid areas where bystanders and customers may be present.

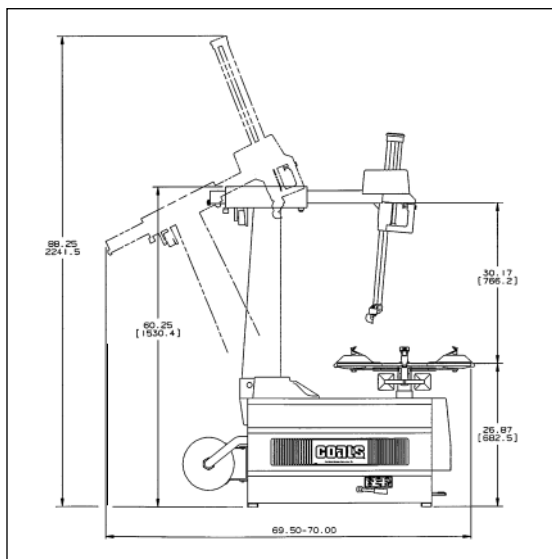

Air Source

The air/electric models require a 5 CFM air source at 150 PSI. The operating pressure range for all models is between 125 PSI and 175 PSI at the machine.

The unit is furnished with a 1/4" pipe thread male fitting for easy connection. This connection is located on the right side of the rear of the machine. A 1/4" ID hose (or pipe) for connection to the machine is satisfactory. Sufficient air pressure assures good performance.

Electrical Source

Electric models require power from a 30 amp, 120 volt electrical circuit with a 125V, 30A, twist-lock receptacle. Refer to the serial tag located on the lower part of the machine for specific electrical requirements for the unit. Have a licensed electrical technician perform any necessary changes to the power source before plugging in the unit. The electrical source must have a solid connection (less than 1 ohm) between ground and building ground.

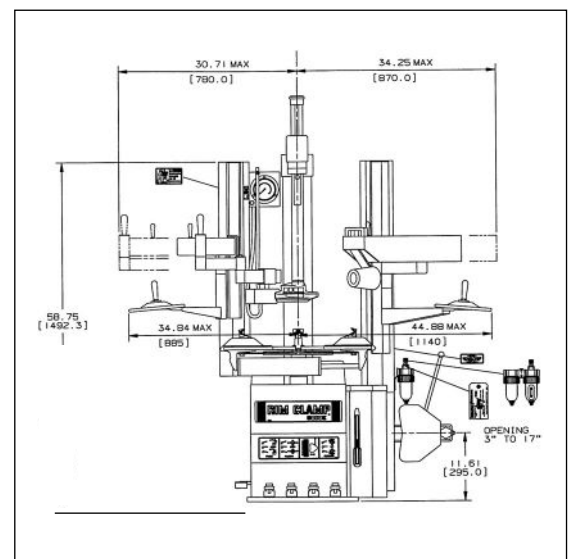

Notes

Notes

ONE WORD FOR SAFETY

R.I.M.

READ INSPECT MOUNT

READ...

Mounting and inflating the wrong size tire can get you hurt. *Read* the size on the tire and make sure it matches the rim. Be especially careful about putting a smaller tire on a larger rim, such as a 16-inch tire on a 16.5-inch rim.

Inflation of a mismatched tire and rim can cause an explosion.

INSPECT...

Before you put any tire on a rim, *inspect* the rim for rust, tough spots, bent edges, or cracks that could prevent the tire from seating right. If you spot any of these problems, don't mount the tire until the rim has been checked by your shop foreman.

Inspect the tire for bead damage.

MOUNT...

Once you've made sure the tire is OK and the right size and the rim is OK, *mount* the tire safely. NEVER, ever lean over the tire when you're inflating it. If a tire does explode, it will go straight up. You don't want to be over the tire if that happens. Also, never over-inflate the tire, even if the bead doesn't seat. Never inflate over 40 PSI. If the tire hasn't seated, something is wrong. Deflate the tire and check it and the rim again. If it doesn't work the second time, try another tire.

BE CAREFUL OF THESE SITUATIONS:

1. Damaged Bead or Beads.

2. Rusty Wheels.
(particularly in the bead seat area)

3. Bent or Cracked Wheels.

4 A. Mismatched.
(A mis-match of a 16-inch tire to a 16.5-inch rim causing an explosion)

4 B. Mismatched.
(16.5-inch tire on a 16-inch rim)

5. Walk-In Tire and Rim.

6. Back Injuries.

7. Hand or Finger Injuries.
(Hands or fingers too close to inflating tire or bead seats which may cause injury.)

8. Standing Clear.
(Never put any part of your body over the tire changer during inflation.)

9. Beads will not Seat at 40 PSI.

10. Improper Inflation.

Remember R.I.M. (Read, Inspect, Mount) for every tire.



FAILURE TO READ AND FOLLOW ALL WARNINGS AND INSTRUCTIONS IN THIS MANUAL CAN LEAD TO SERIOUS PERSONAL INJURY OR DEATH TO OPERATOR OR BYSTANDER.

THE OWNER IS RESPONSIBLE FOR MAINTAINING THE OPERATION INSTRUCTIONS AND DECALS FOR OPERATOR REFERENCE. FOR ADDITIONAL COPIES, CONTACT THE COATS® COMPANY, 1601 J.P. HENNESSY DRIVE, LAVERGNE, TENNESSEE, 37086 - (800) 688-6359.

TIRE FAILURE UNDER PRESSURE IS HAZARDOUS! This tire changer Will Not Restrain Exploding Tires, rims or other related equipment.

TIRES CAN EXPLODE, ESPECIALLY IF INFLATED BEYOND SPECIFIED LIMITS. DO NOT EXCEED TIRE MANUFACTURERS RECOMMENDED AIR PRESSURE.

AN EXPLODING TIRE, RIM, OR BEAD SEATING EQUIPMENT MAY PROPEL UPWARD AND OUTWARD WITH SUFFICIENT ENERGY TO CAUSE SERIOUS INJURY OR DEATH TO OPERATOR AND/OR BYSTANDERS.